

TECH GUIDE

DataCore™ SANsymphony™ and InfiniFlash™ IF150 Platform Configuration Guide for iSCSI

Table of Contents

Introduction.....	5
Reference Configuration	5
Deployment Topology.....	6
Bill of Materials.....	6
Server Hardware.....	6
Ethernet Network Switches	7
InfiniFlash IF150 Configuration	7
SANsymphony Host System.....	7
BIOS Settings	8
Configure Dell iDRAC Network.....	8
Memory Settings	8
Processor Settings.....	9
System Profile Settings.....	10
SATA Settings.....	11
Operating System Configuration	12
Windows Power Plan	12
Chipset Firmware.....	12
Networking Configuration	13
Time Server	13
IP Addressing	13
DNS/Hostname.....	13
NIC Bonding.....	13
iSCSI Port Naming	13
HBA Configuration	14
Upgrading the BIOS.....	14
Upgrading the Driver.....	15
HBA BIOS Settings.....	15
BIOS Interrupt 13 Configuration	15
Set the Maximum Queue Depth.....	19
Multipathing.....	21
Client Multipathing	21
DataCore Multipathing.....	21
InfiniFlash IF150 Configuration	22
InfiniFlash Cabling.....	22
IFCLI Installation	22
InfiniFlash Firmware Level.....	22
InfiniFlash Zone Configuration.....	26
Create Support Bundle	27
DataCore Configuration.....	27
Pre-Installation Guidance	27
Installing DataCore SANsymphony.....	28

- Licensing SANsymphony 29
- SANsymphony iSCSI Settings29**
- SANsymphony iSCSI Power Shell Script30**
- Configuring DataCore SANsymphony32**
 - Join the DataCore Servers..... 32
 - Configure the iSCSI Port Rules 32
 - Configuring iSCSI Storage Connection 32
 - Create the iSCSI Mirror Connection..... 33
 - Create Disk Pools 33
 - Auto-Tiering 36
 - Create a Virtual Disk 36
- Logging and Monitoring 39**
 - Live Performance Monitoring40**
 - Server Group Alerts.....40**
 - Operations Event Log41**
 - Host Log Messages.....41**
 - Task Manager42**
- References 43**

Table of Figures

Figure 1) Deployment topology	6
Figure 2) iDRAC configuration.....	8
Figure 3) Memory configuration.....	9
Figure 4) Hyper-threading and virtualization configuration.....	10
Figure 5) Disable Dell Controlled Turbo.....	10
Figure 6) CPU power management configuration.....	11
Figure 7) SATA settings	11
Figure 8) Windows power plan.....	12
Figure 9) SAS configuration utility	16
Figure 10) Advanced adapter properties.....	16
Figure 11) Advanced device properties	17
Figure 12) Setting Maximum INT 13	17
Figure 13) Saving adapter changes	18
Figure 14) HBA driver restart	20
Figure 15) Client multipathing	21
Figure 16) InfiniFlash cabling configuration.....	22
Figure 17) DataCore SANsymphony Deployment Wizard	28
Figure 18) Activate SANsymphony license keys	29
Figure 19) Configure iSCSI port rules	32
Figure 20) Create a disk pool	34
Figure 21) Add physical disks to the disk pool.....	34
Figure 22) Create a virtual disk	36
Figure 23) Select storage source.....	37
Figure 24) Setting virtual disk advanced options.....	37
Figure 25) Displaying the virtual disks	38
Figure 26) Serve virtual disks to hosts	38
Figure 27) Select paths.....	39
Figure 28) Verify the virtual disk paths.....	39
Figure 29) Monitoring live performance	40
Figure 30) Server group alerts	40
Figure 31) Operations event log	41
Figure 32) Host log messages	41
Figure 33) Task manager.....	42

Introduction

This document provides a reference guide for configuring and tuning DataCore SANsymphony and the InfiniFlash IF150 platform for an iSCSI deployment. The guidance contained in this document is subject to change as SANsymphony and/or InfiniFlash firmware and drivers may be updated periodically. This is not a performance guide; rather it provides the general configuration and tuning options to deploy DataCore SANsymphony on the InfiniFlash IF150.

SANsymphony software, powered by DataCore Parallel I/O technology, provides a flexible platform for enterprise environments. From its inception, SANsymphony has been designed as a parallel storage software solution; it is uniquely able to scale due to its underlying hardware environment and to do so in both conventional storage topologies and in converged environments. By employing parallel processing, the software balances the load and better utilizes memory, compute, and storage resources to accelerate the I/O between the external workload and the storage subsystem. This parallel I/O architecture further enhances the system's ability to process intensive and mixed workloads typical of database and other transactional-oriented applications.

The InfiniFlash IF150 all-flash storage platform empowers medium and large-scale infrastructure and data centers to deliver massive capacity and throughput to address the demands of capacity workloads at scale without compromise. The IF150 enables the use of flash memory for primary and secondary storage with low total acquisition costs and extremely compelling total cost of ownership (TCO). InfiniFlash can be configured with up to 64 hot-swappable cards (devices), each providing 8TB of capacity in the current release. Together, the cards deliver up to half a petabyte (512TB) of raw flash storage in a 3U enclosure. InfiniFlash delivers a high performance, petabyte scale solution for virtualization, databases, or Big Data.

This guide is not an endorsement of DataCore SANsymphony by Western Digital Corporation, and no warranty of the product is either expressed or implied.

Reference Configuration

The reference configuration for this deployment is an iSCSI implementation with DataCore SANsymphony 10.0 PSP5 Update 1 and the InfiniFlash IF150. The DataCore SANsymphony controller hosts are configured in a high-availability (HA) configuration. The data pools are configured in a RAID 1 mirror across the two SANsymphony controllers with a dedicated 40Gbps Ethernet connection. Each data pool can contain one or more 8TB flash drives.

SANsymphony can be deployed on many commodity x86-64 server architectures and supports Fibre Channel (FC) and iSCSI, as well as NAS protocols such as NFS and SMB through Windows® File Services. The screenshots and configuration options in this guide are specific to the Dell™ PowerEdge™ R730 servers; other server installations may vary.

For more information about the hardware supported by DataCore SANsymphony, visit the [DataCore Support](#) website.

Deployment Topology

Figure 1) Deployment topology

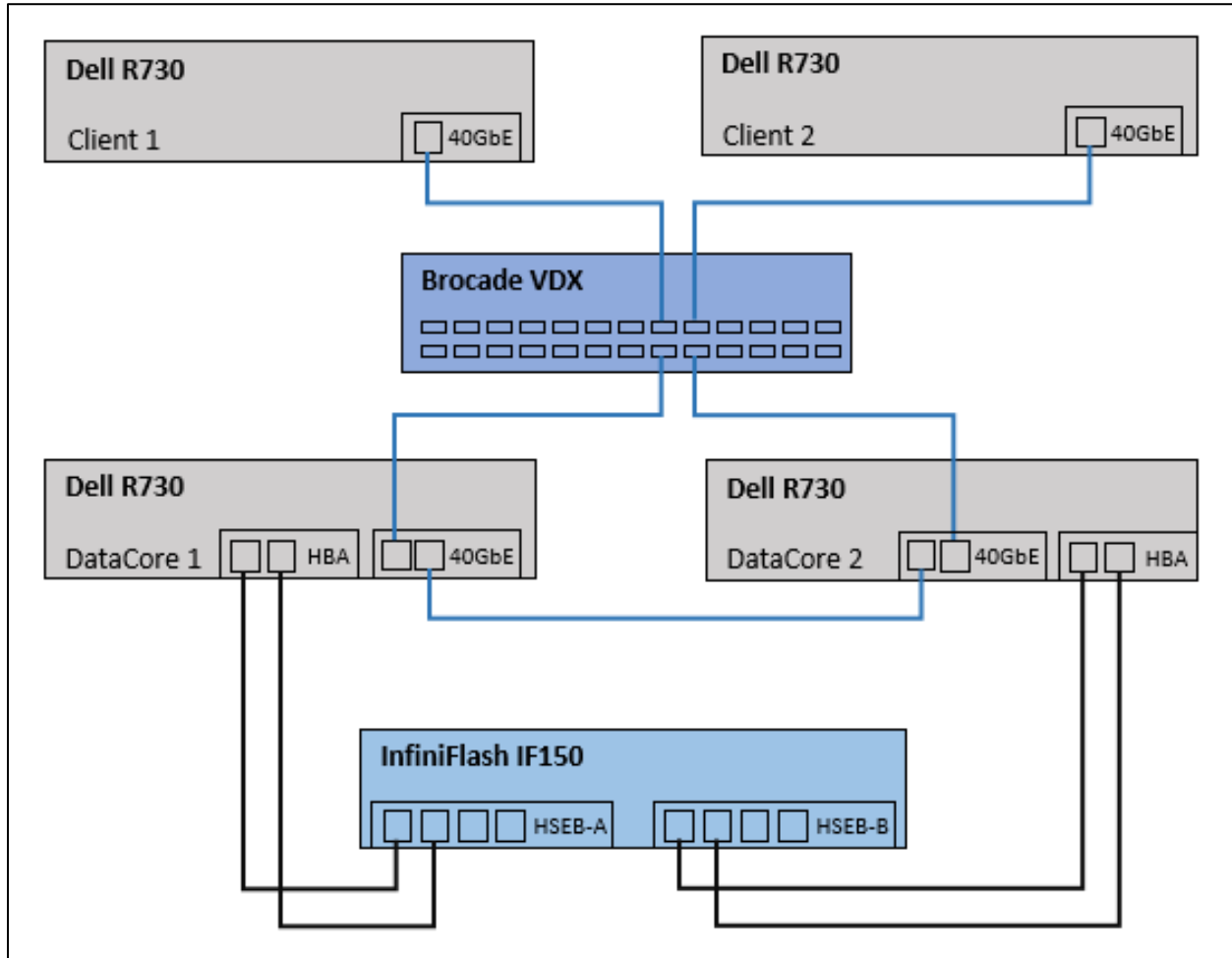

Note: This paper is not a performance guide and no effort has been made to tune the configuration for optimal performance results.

Bill of Materials

Server Hardware

- 2 x Dell PowerEdge R730 client systems
- 2 x Dell PowerEdge R730 host servers
- Dell R730 PowerEdge server specifications:
 - 2 x Intel® Xeon® E5-2680 v3 CPUs
 - 128GB DRAM

- 1 x Avago SAS 9300-8e 12G 2-port HBA
- 1 x Mellanox® ConnectX® -3 40GbE adapter
- 1 x 1GbE NIC (management)
- Chipset driver 8H5MF_WN64 10.1.2.19 A05

Ethernet Network Switches

- 1 x 1GbE network management switch
- 1 x Brocade® VDX® 6940 40GbE network switch

InfiniFlash IF150 Configuration

- 1 x InfiniFlash IF150
- 64 x 8TB flash cards
- 4 x 12Gbps MiniSAS cables
- Z2 zoning configuration
- IF150 installer version 2.1.2.0.0.RC
- IF150 ifcli tool version 2.2.12

SANsymphony Host System

- Microsoft® Windows® 2012 R2
 - Microsoft Windows 2012 R2
 - Microsoft recommended updates
 - DataCore recommended updates
 - <https://support.microsoft.com/en-us/kb/3102997>
 - <http://support.microsoft.com/kb/2990170>
 - <http://support.microsoft.com/kb/2869606>
 - <https://support.microsoft.com/en-us/kb/3000850>
 - [Microsoft .NET Framework Version 4.6.1 Redistributable Package](#)
 - [Microsoft Visual C++ 2015 Redistributable Packages](#)
- SANsymphony 10.0 PSP5, Update 1
 - DataCore Tuning Power Shell script
 - iSCSI-Settings_Helper_v1.3.ps1

BIOS Settings

Configure Dell iDRAC Network

Set the remote IP, gateway, and subnet mask in iDRAC to enable access to the remote console and click the **Apply** button.

Figure 2) iDRAC configuration

The screenshot shows the iDRAC configuration interface. On the left is a navigation tree with 'iDRAC Settings' expanded to 'Network'. The main area displays 'IPv4 Settings' in a table format.

Attribute	Value
Enable IPv4	<input checked="" type="checkbox"/>
DHCP Enable	<input type="checkbox"/>
Static IP Address	<input type="text" value="10.60.95.121"/>
Static Gateway	<input type="text" value="10.60.94.1"/>
Static Subnet Mask	<input type="text" value="255.255.254.0"/>
Use DHCP to obtain DNS server addresses	<input type="checkbox"/>
Static Preferred DNS Server	<input type="text" value="8.8.8.8"/>
Static Alternate DNS Server	<input type="text" value="0.0.0.0"/>

Memory Settings

The following memory settings provide tuning for performance and power efficiency. These can have a major impact on overall system performance, and are not generally considered power efficiency options. However, these selections can impact system performance and power.

Configure the following settings in the System BIOS:

Select **System BIOS | Memory Settings** and configure these options:

Memory Operating Mode → Optimizer Mode

Node Interleaving → Disabled

Figure 3) Memory configuration

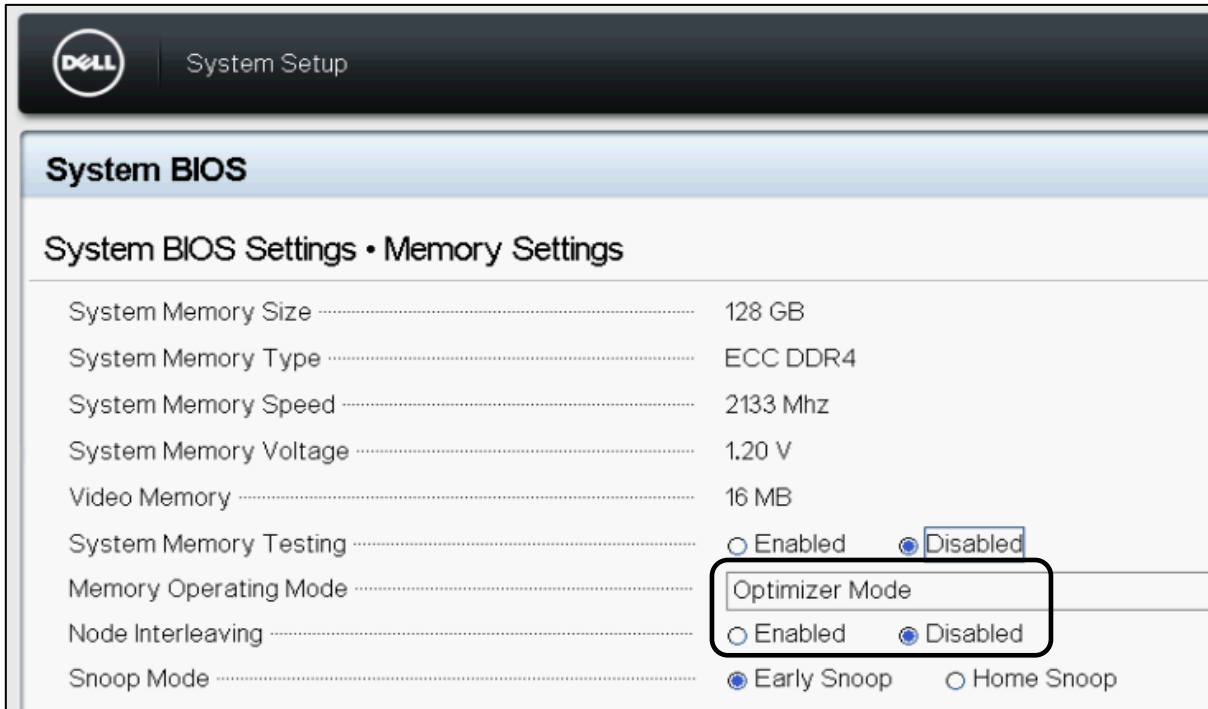

Processor Settings

Disable the following settings in the System BIOS:

- Select **System BIOS | Processor Settings** and set the following options:
 - Logical Processor → Enabled
 - Virtualization Technology → Enabled
 - Dell Contolled Turbo → Disabled

Figure 4) Hyper-threading and virtualization configuration

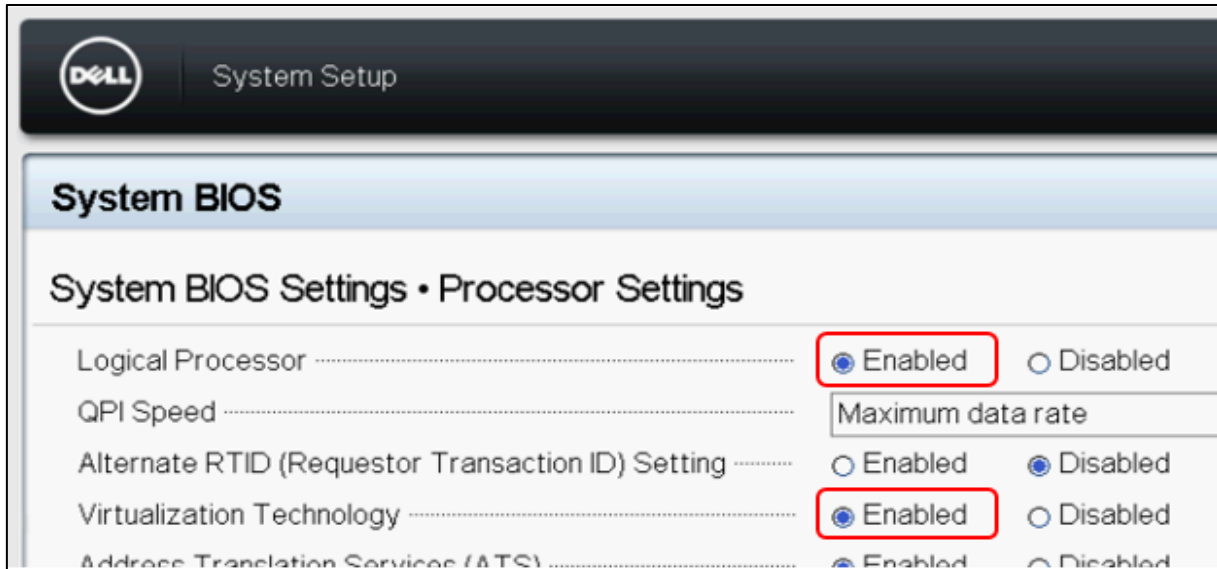
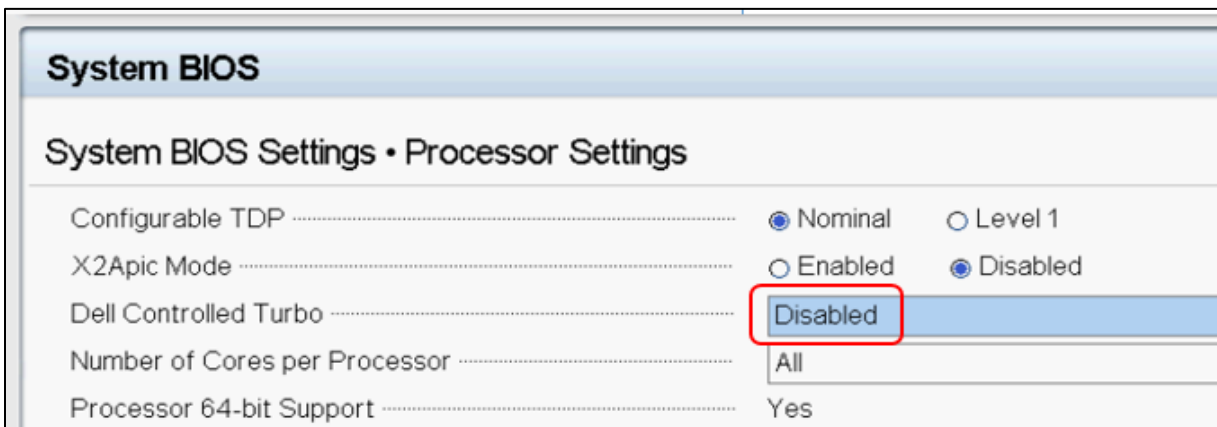

Figure 5) Disable Dell Controlled Turbo



System Profile Settings

Select the following option in the System BIOS:

- Select **System BIOS | System Profile Settings** and set the following option:
System Profile → Performance
C States → Disabled (automatically disabled when Performance is selected)

Figure 6) CPU power management configuration

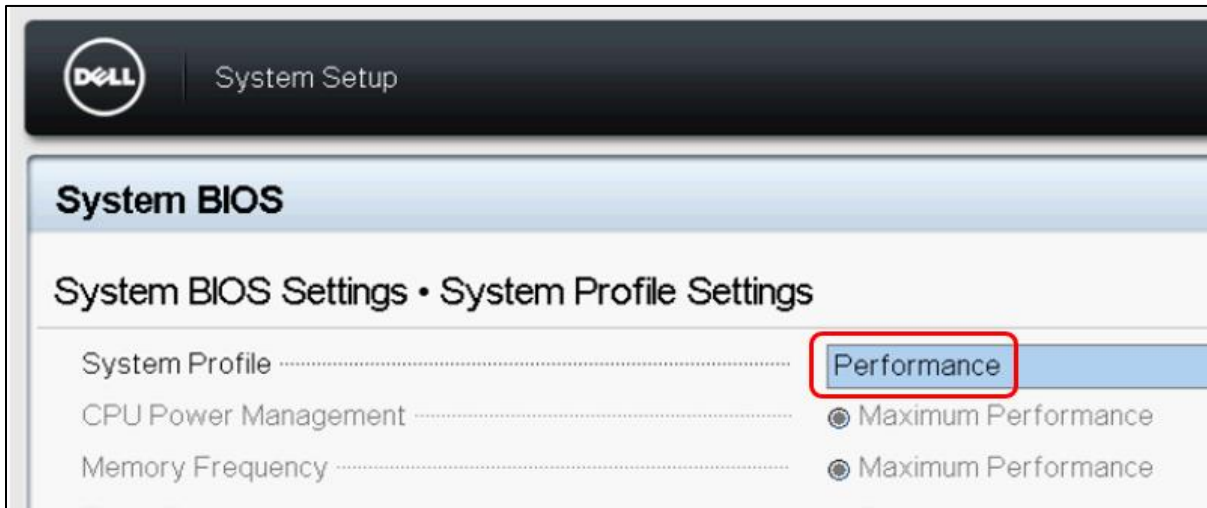

SATA Settings

Select the following option in the System BIOS:

- Select **System BIOS | SATA Settings** and set the following option:
Embedded SATA → AHCI Mode

Figure 7) SATA settings

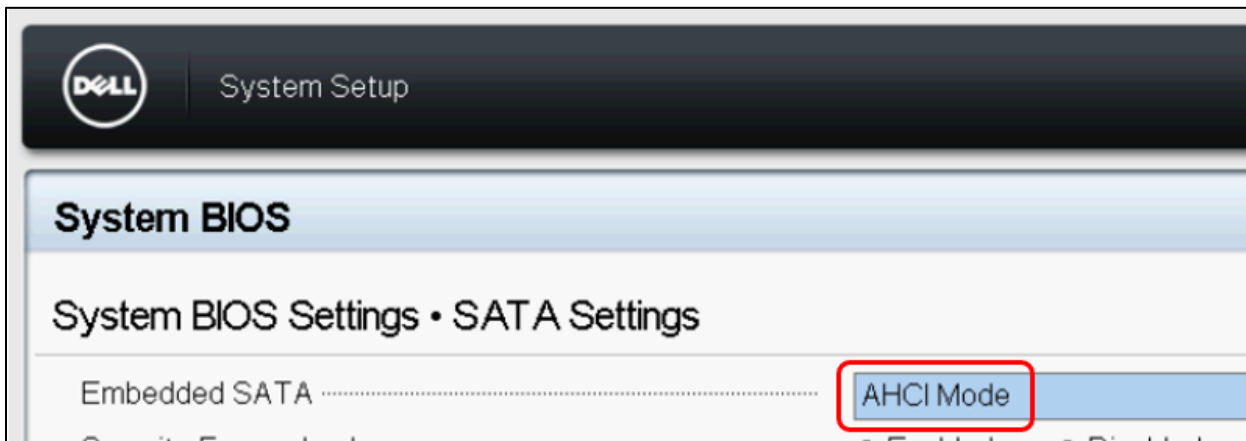

Operating System Configuration

The clients and DataCore servers are running Windows Server 2012 R2 with all recommended Windows Server 2012 R2 updates, as of the date of publishing.

The following hotfixes have been installed as recommended by DataCore:

- <https://support.microsoft.com/en-us/kb/3102997>
- <http://support.microsoft.com/kb/2990170>
- <http://support.microsoft.com/kb/2869606>
- <https://support.microsoft.com/en-us/kb/3000850>

The following packages have been installed as required by DataCore:

- [Microsoft .NET Framework Version 4.6.1 Redistributable Package](#)
- [Microsoft Visual C++ 2015 Redistributable Packages](#)

Windows Power Plan

To ensure the Windows Server is providing the maximum performance, set the Windows Power Plan to High Performance.

Figure 8) Windows power plan

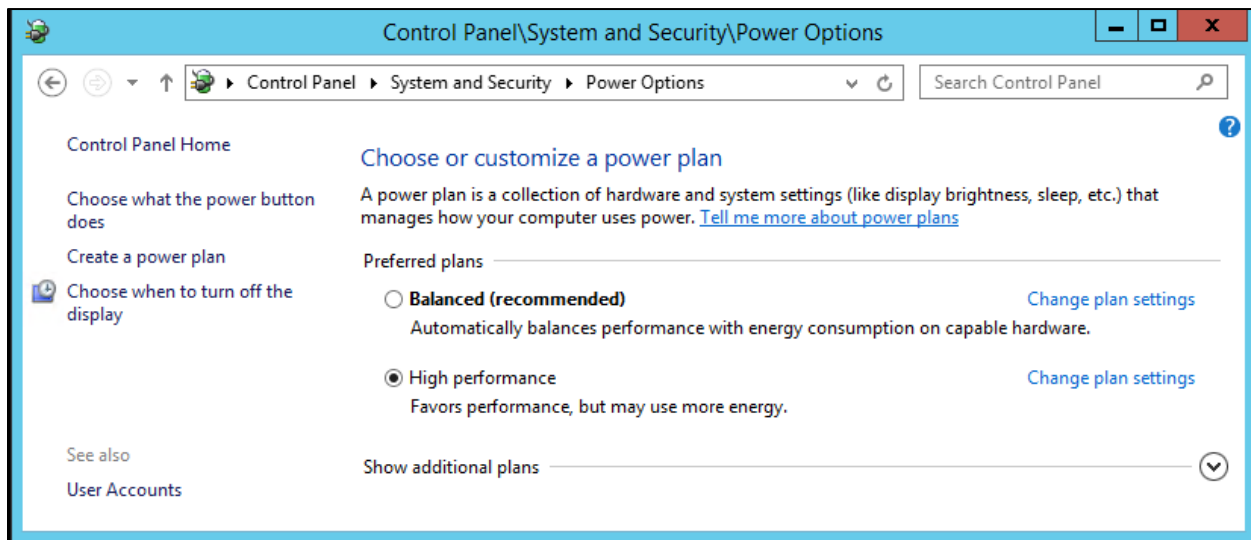

Chipset Firmware

Verify the Chipset firmware is functioning correctly in the Windows Device Manager. This deployment uses the Dell Chipset driver from the Dell Support site at <http://www.dell.com/support/home/us/en/04/Drivers/DriversDetails?driverId=6DK2N>.

Networking Configuration

Time Server

Configuring Network Time Protocol (NTP) is recommended for all hosts to ensure the system clocks are synchronized. System clocks which are not synchronized may cause debugging and authentication issues. In Windows Server 2012 R2, NTP can be configured in the Windows PowerShell™ using the `w32tm` command. After configuring the NTP servers, restart the `w32time` service.

```
PS C:\DataCore> w32tm /config /manualpeerlist:"0.pool.ntp.org 1.pool.ntp.org"  
/syncfromflags:MANUAL  
The command completed successfully.  
  
PS C:\DataCore> stop-service w32time  
  
PS C:\DataCore> start-service w32time
```

IP Addressing

For this deployment, management and data network IP addresses, netmask, and routing are set using a DHCP server. Configuration of DHCP is outside the scope of this document.

Note: Management and data network addresses should be on different network IP ranges.

DNS/Hostname

Hostnames are configured during system installation and must be DNS resolvable.

NIC Bonding

NIC bonding is not configured in this deployment.

iSCSI Port Naming

To allow easy identification of the iSCSI ports, a recommended best practice is to rename the ports for each connection. The name should include the hostname and function. For example:

- DataCore 1 Management: `tme-sj-s21-mgmt`
- DataCore 2 Management: `tme-sj-22-mgmt`
- Client 1 iSCSI Initiator: `tme-sj-23-initiator`
- Client 2 iSCSI Initiator: `tme-sj-24-initiator`
- DataCore 1 iSCSI Target: `tme-sj-s21-target`
- DataCore 2 iSCSI Target: `tme-sj-s22-target`
- DataCore 1 iSCSI Mirror: `tme-sj-s21-mirror`
- DataCore 2 iSCSI Mirror: `tme-sj-s22-mirror`

HBA Configuration

The Avago 9300-8e HBA firmware and BIOS versions are configured as follows:

Type	Title	Version
BIOS	SAS3_UEFI_BSD_P12	13.0
Driver	LSI_SAS3.SYS	2.50.65.01
Firmware	Installer_P12_for_MSDOS_and_Windows	13.0
Management Tools	SAS3IRCU for SAS3 Controller	13.0

To download the Avago 9300-8e HBA firmware, BIOS, and drivers:

- Firmware and BIOS downloads: [Avago Support](#) website
- Driver download: [Avago Support](#) website

Note: Occasionally, the latest Avago 9300-8e HBA drivers do not install correctly on Windows Server 2012 R2. If this happens, use an earlier version of the driver (i.e. 2.50.65.01).

Upgrading the BIOS

The command-line instruction to flash the IT UEFI SAS3 BSD HII driver is:

```
sas3flash -c <n> -b mpt3x64.rom
```

where <n> is the controller number (starting with zero (0)).

```
C:\DataCore> sas3flash.exe -c 0 -b mpt3x64.rom
Avago Technologies SAS3 Flash Utility
Version 13.00.00.00 (2016.03.07)
Copyright 2008-2016 Avago Technologies. All rights reserved.

    Adapter Selected is a Avago SAS: SAS3008(C0)

    Executing Operation: Flash BIOS Image

        Validating BIOS Image...

        BIOS Header Signature is Valid

        BIOS Image has a Valid Checksum.

        BIOS PCI Structure Signature Valid.

        BIOS Image Compatible with the SAS Controller.

        Attempting to Flash BIOS Image...

        Verifying Download...

        Flash BIOS Image Successful.

    Finished Processing Commands Successfully.
    Exiting SAS3Flash.
```

Upgrading the Driver

This procedure installs or upgrades the `lsi_sas3.sys` driver for the Windows Server 2012 R2 system.

Note: When an Avago SAS Gen3 adapter is added to an existing system installation, the new adapter is automatically detected at the next reboot. When the **Update Driver Software Wizard** appears at boot, continue from step 8 below.

1. Boot Windows 2012R2 and logon as a user that has Administrator privileges.
2. Start the Device Manager.
3. Click the **arrow** to the left of the Storage Controllers line. Find the adapter desired for the driver upgrade and **double-click the entry**. Click on the **Driver** tab.
4. Click on the **Update Driver** button to update existing driver. The Update Driver Software wizard begins.
5. Click on the **Browse my computer** for driver software selection.
6. Click on the **Let me pick...** selection at the bottom of the window.
7. Click on the **Have Disk** button and type the path to the driver, or click on the **Browse** button. Select the location for the driver package which matches the processor architecture of the system (x86). After the path to the driver has been established, click the **OK** button.
8. Select the driver from the list and click on the **Next** button.
9. The system will load the driver from the driver package media.
10. Click **Yes** to continue the installation.

The system copies the driver to the system disk. For any adapter other than the boot adapter, the updated driver will become active immediately. For the boot adapter, a message displays indicating that you must reboot your system for the new driver to take effect.

11. Click on the **Close** button to complete the driver upgrade.

HBA BIOS Settings

The following settings are configured on the Avago 9300-8e SAS HBA.

BIOS Interrupt 13 Configuration

Set the Interrupt value for each HBA BIOS adapter either to 0 or 1. If this is not done, the host may hang when rebooted.

To set the Interrupt value perform the following steps:

At boot time, press **Ctrl+C** to run the SAS Configuration Utility and press Enter.

Select the **SAS8300-16e** HBA card and press **Enter**.

Note: Each SAS HBA card must be configured separately.

Figure 9) SAS configuration utility



Select **Advanced Adapter Properties** and press **Enter**.

Figure 10) Advanced adapter properties

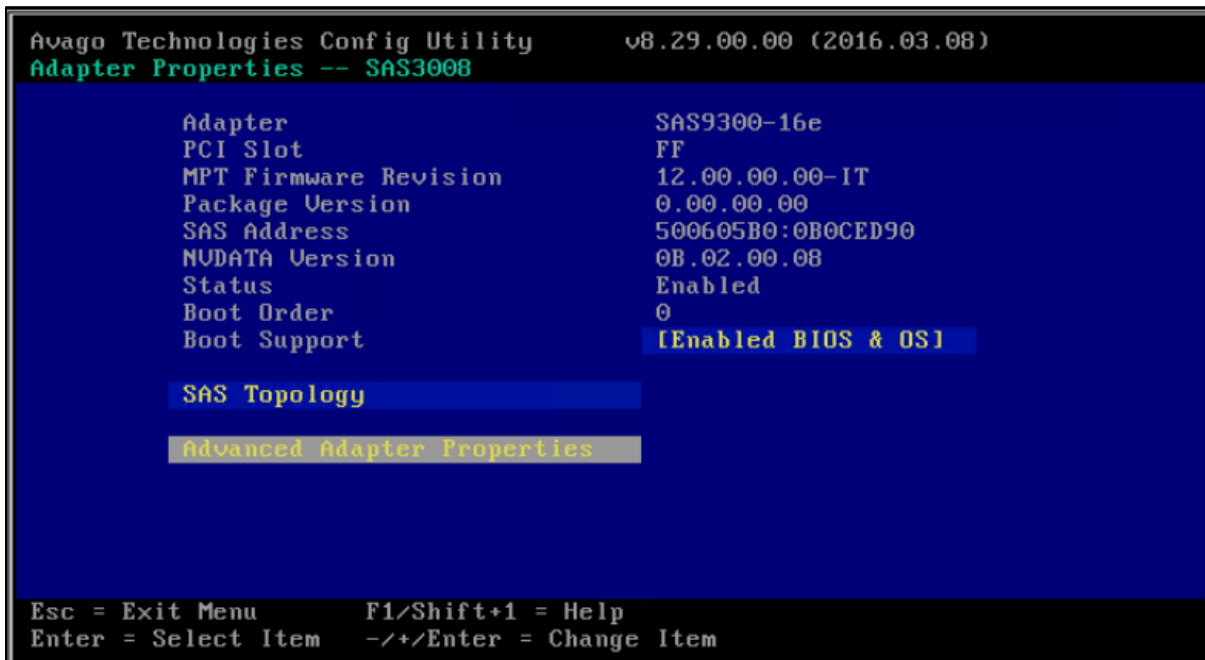

Select **Advanced Device Properties** and press **Enter**.

Figure 11) Advanced device properties

```

Avago Technologies Config Utility      v8.29.00.00 (2016.03.08)
Advanced Adapter Properties -- SAS3008

      IRQ                      0F
      NUM                      Yes
      IO Port Address          3000
      Chip Revision ID        02

Advanced Device Properties
Adapter Timing Properties
Advanced Port Properties

Esc = Exit Menu      F1/Shift+1 = Help
Enter = Select Item  -/+Enter = Change Item

```

Set the Maximum INT 13 Devices for this Adapter to either **0** or **1**.

Figure 12) Setting Maximum INT 13

```

Avago Technologies Config Utility      v8.29.00.00 (2016.03.08)
Advanced Device Properties -- SAS3008

Maximum INT 13 Devices for this Adapter  1

IO Timeout for Block Devices            10
IO Timeout for Block Devices(Removable) 10
IO Timeout for Sequential Devices       10
IO Timeout for Other Devices            10
Start Stop Unit Timeout                 30

LUNs to Scan for Block Devices          [All]
LUNs to Scan for Block Devices(Removable) [All]
LUNs to Scan for Sequential Devices     [All]
LUNs to Scan for Other Devices         [All]

Removable Media Support                 [None]

Restore Defaults

Esc = Exit Menu      F1/Shift+1 = Help
Enter = Select Item  -/+Enter = Change Item

```

Return to the first screen of the SAS Configuration Utility and select **Save changes then exit this menu** and press **Enter**.

Figure 13) Saving adapter changes

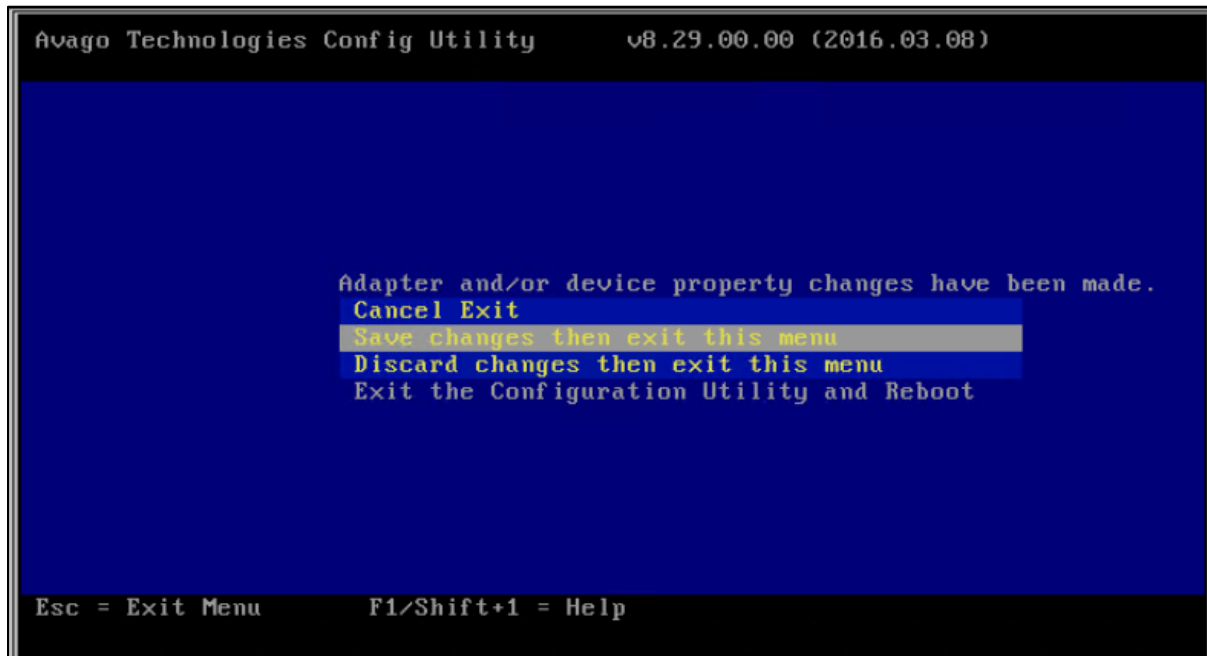

Set the Maximum Queue Depth

For this deployment, the maximum queue depth has been set to 64. This value works well for a wide variety of workloads. The queue depth for this deployment has been configured using the Windows Driver Configuration Utility (WDCFG) for the Avago 9300-8e HBA.

To set the maximum queue depth with the WDCFG utility, run the `wdcfg -s MaxSASQueueDepth` command.

```
C:\DataCore> wdcfg -s MaxSASQueueDepth=64

LSI Windows Host Driver Configuration Utility (wdcfg)
Version 2.00.17.01, Built Jun 26 2013 11:43:02

Snapshot Before Changes:
MaxSASQueueDepth = 254

Snapshot After Changes:
MaxSASQueueDepth = 64

Config Params in Snapshot Updated to specified values
```

After setting the `MaxSASQueueDepth` parameter value, the new driver configuration must be activated with the `wdcfg -a` command.

```
C:\DataCore> wdcfg -a

LSI Windows Host Driver Configuration Utility (wdcfg)
Version 2.00.17.01, Built Jun 26 2013 11:43:02

DRIVER HAS NOT BEEN RESTARTED.  RESTART DRIVER TO MAKE CHANGES ACTIVE.
Current snapshot activated to driver LSI_SAS3
```

Finally, the HBA driver must be disabled and re-enabled to load the new configuration. From the Device Manager, **select** the LSI Adapter in Storage Controllers. **Right-click** the LSI Adapter and select **Disable**. After disabling the LSI adapter, **right-click** the LSI adapter and select **Enable**.

Figure 14) HBA driver restart

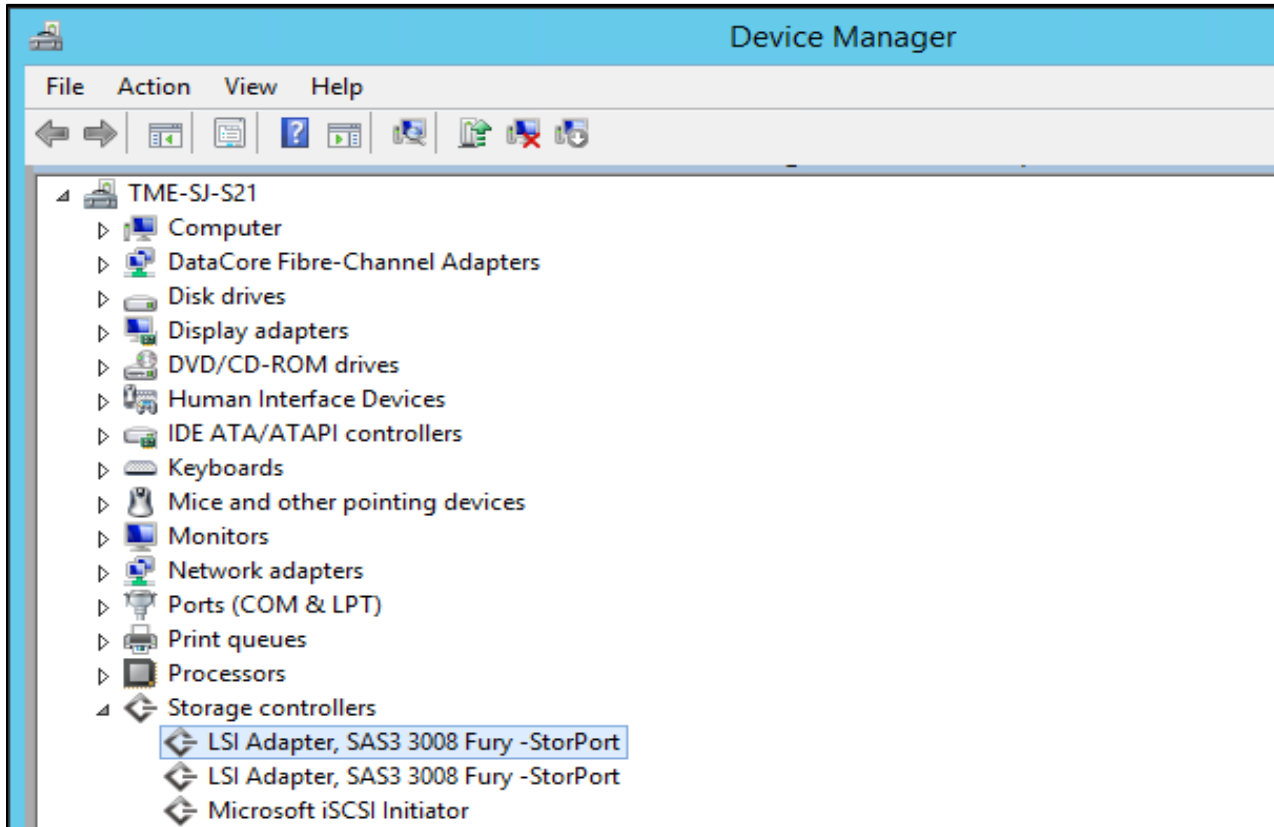

To view the current configuration, enter the `wdcfg -q h` command.

```
C:\DataCore> wdcfg.exe -q h

LSI Windows Host Driver Configuration Utility (wdcfg)
Version 2.00.17.01, Built Jun 26 2013 11:43:02

=====
History Stack Contents
Target Driver = LSI_SAS3
=====

-----
History Stack Index: 0

MaxSASQueueDepthepth = 64

-----
History Stack Index: 1

Placeholder = 0
```

```
History Stack Index: 2
Placeholder = 0
```

For more information about the Windows Driver Configuration Utility, review the Windows Driver Configuration Utility (WDCFG) User Guide included with the installation driver.

Multipathing

Client Multipathing

Multipathing I/O (MPIO) for the client initiator hosts is configured using DataCore’s Windows Integration Kit. The kit provides an improved MPIO driver that enables advanced updates to the SANsymphony user interface. The Windows Integration Kit is available on the [DataCore Support](#) website.

DataCore Multipathing

Multipath I/O (MPIO) for the SANsymphony hosts is configured in the Windows Server Manager. After starting the Server Manager, select the **Manage** menu and choose **Add Roles and Features**. Click **Next** until reaching the Select Features window. Scroll down the list of features and **select Multipath I/O**.

Figure 15) Client multipathing

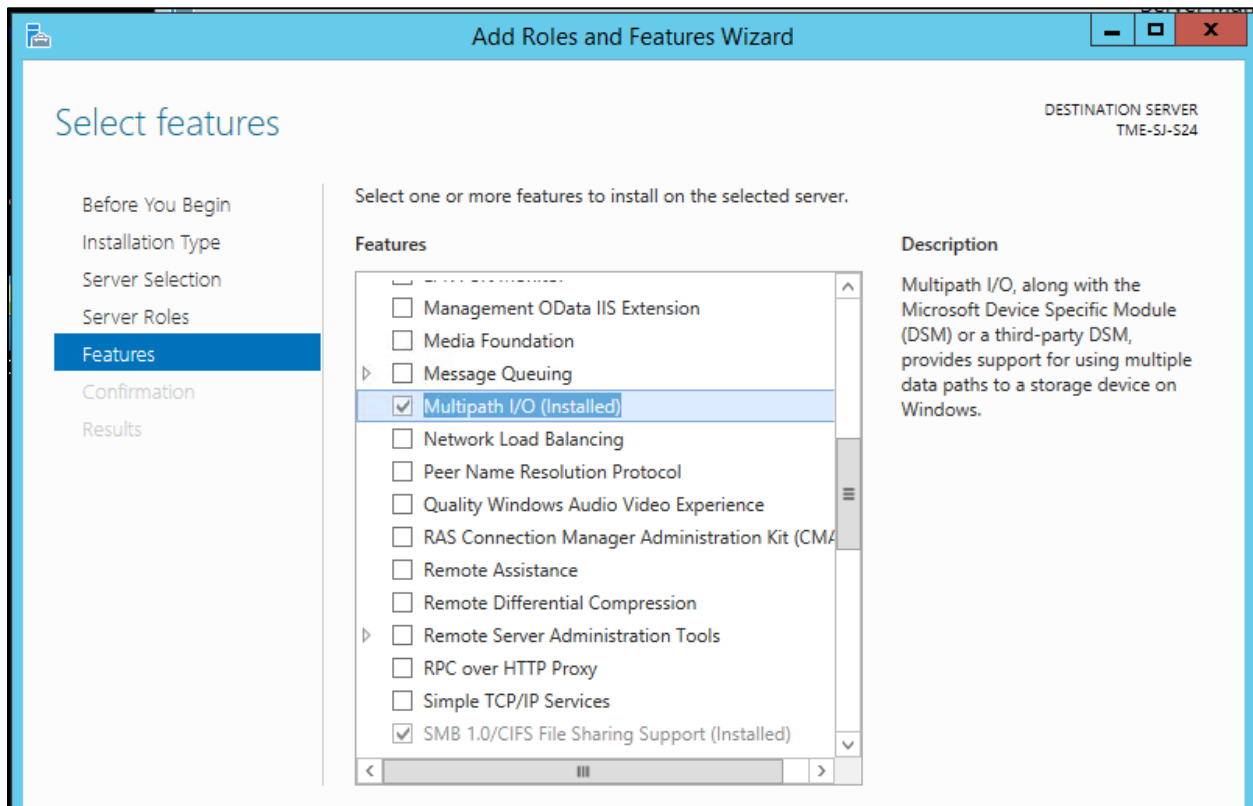

InfiniFlash IF150 Configuration

InfiniFlash Cabling

This deployment uses an A2 cabling configuration:

Figure 16) InfiniFlash cabling configuration

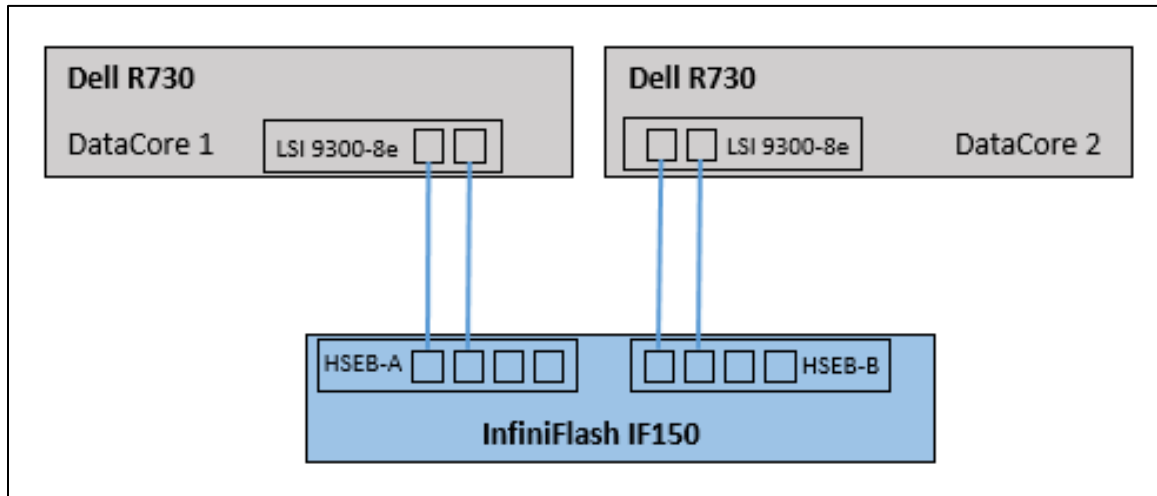

IFCLI Installation

For this configuration, the system has been installed with the IF150 Windows 2.1.2.0.0-IF-150-rc software binaries. Download the IF150 ifcli.exe, firmware binary, and the zone package file from the InfiniFlash support webpage at <https://link.sandisk.com>:

- ifcli.exe
- 2.1.2.0.0.RC.bin
- InfiniFlashZoneCnf_01.11.zpkg

Download all three files and transfer them to the DataCore server.

Note: The hash after 'SanDisk-bundle-' is unique for each download.

InfiniFlash Firmware Level

Below are the firmware versions for the IF150 2.1.2.0.0 RC release:

Element	Firmware	BootCode	PCU Boot	PCU FW	ISTR
HSE	A01A	BC04	NA	NA	I008
DSE	A01A	BC04	NA	NA	I008
FPGA	1.00.023D	NA	NA	NA	NA
Drive	62EL	NA	FD4E	FD4E	NA

To validate the IF150 firmware version, run the `ifcli enclo version` command. If necessary, update the firmware of the InfiniFlash to the appropriate version.

```
C:\DataCore> ifcli enclo version
SanDisk ifcli version 2.2.12
Copyright (C) 2016 SanDisk
08/23/2016 17:19:18

Enclosure : enclo
=====

Element          Firmware Version  BootCode Version  PCU Boot Version  PCU FW Version  ISTRVersion
-----
enclo/hse0       A01A              BC04              NA                 NA               I008
enclo/hse1       A01A              BC04              NA                 NA               I008
enclo/hse0/d1    A01A              BC04              NA                 NA               I008
enclo/hse0/d3    A01A              BC04              NA                 NA               I008
enclo/hse1/d0    A01A              BC04              NA                 NA               I008
enclo/hse1/d2    A01A              BC04              NA                 NA               I008
FPGA 0           1.00.023D         NA                 NA                 NA               NA
FPGA 1           1.00.023D         NA                 NA                 NA               NA
enclo/slot0/drive 62EL              NA                 FD4E               FD4E             NA
enclo/slot1/drive 62EL              NA                 FD4E               FD4E             NA
enclo/slot4/drive 62EL              NA                 FD4E               FD4E             NA
enclo/slot5/drive 62EL              NA                 FD4E               FD4E             NA
enclo/slot8/drive 62EL              NA                 FD4E               FD4E             NA
enclo/slot9/drive 62EL              NA                 FD4E               FD4E             NA
enclo/slot12/drive 62EL              NA                 FD4E               FD4E             NA
enclo/slot13/drive 62EL              NA                 FD4E               FD4E             NA
enclo/slot16/drive 62EL              NA                 FD4E               FD4E             NA
enclo/slot17/drive 62EL              NA                 FD4E               FD4E             NA
enclo/slot20/drive 62EL              NA                 FD4E               FD4E             NA
enclo/slot21/drive 62EL              NA                 FD4E               FD4E             NA
enclo/slot24/drive 62EL              NA                 FD4E               FD4E             NA
enclo/slot25/drive 62EL              NA                 FD4E               FD4E             NA
enclo/slot28/drive 62EL              NA                 FD4E               FD4E             NA
enclo/slot29/drive 62EL              NA                 FD4E               FD4E             NA
enclo/slot33/drive 62EL              NA                 FD4E               FD4E             NA
enclo/slot34/drive 62EL              NA                 FD4E               FD4E             NA
enclo/slot35/drive 62EL              NA                 FD4E               FD4E             NA
enclo/slot38/drive 62EL              NA                 FD4E               FD4E             NA
enclo/slot39/drive 62EL              NA                 FD4E               FD4E             NA
enclo/slot42/drive 62EL              NA                 FD4E               FD4E             NA
enclo/slot43/drive 62EL              NA                 FD4E               FD4E             NA
enclo/slot46/drive 62EL              NA                 FD4E               FD4E             NA
enclo/slot47/drive 62EL              NA                 FD4E               FD4E             NA
enclo/slot50/drive 62EL              NA                 FD4E               FD4E             NA
enclo/slot51/drive 62EL              NA                 FD4E               FD4E             NA
enclo/slot53/drive 62EL              NA                 FD4E               FD4E             NA
enclo/slot56/drive 62EL              NA                 FD4E               FD4E             NA
enclo/slot57/drive 62EL              NA                 FD4E               FD4E             NA
enclo/slot60/drive 62EL              NA                 FD4E               FD4E             NA
enclo/slot61/drive 62EL              NA                 FD4E               FD4E             NA

Warning: Unable to access one or more drives because of zoning or drive reservation or offline/blocked device(s)

Command Executed Successfully.
```

Note: If the IF150 enclosure was previously assigned a zone configuration, the firmware version of the drives must be checked for each host.

Updating the IF150 firmware is performed with the `ifcli enc10 update` command. This command must be completed on each server host connected to the IF150. After executing the firmware update on all hosts, reboot the InfiniFlash IF150.

```
C:\DataCore> ifcli enc10 version
SanDisk ifcli version 2.2.12
Copyright (C) 2016 SanDisk
08/23/2016 17:39:18

Enclosure                : enc10
Enclosure Logical Id     : 5001E8200006B0C0
Compatible                : Yes
  Enclosure Power Cycle Required? : Yes
Update needed from secondary host? : Yes
Enclosure State          : OK
```

Element	Type	Upgradable	Current Ver	New Ver	OS Device Name	IO Suspend?
Power Cycle?						
-----	-----	-----	-----	-----	-----	-----
enc10/hse0	ISTR	Updateable	I006	I007	/dev/sg2	No
Yes						
enc10/hse0	BootCode	NotRequired	BC04	BC04	/dev/sg2	No
No						
enc10/hse0	Firmware	Updateable	A017	A018	/dev/sg2	No
Yes						
enc10/hse1	ISTR	Unreachable	I006	I007	NA	No
Yes						
enc10/hse1	BootCode	NotRequired	BC04	BC04	NA	No
No						
enc10/hse1	Firmware	Unreachable	A017	A018	NA	No
Yes						
enc10/hse0/d1	ISTR	Updateable	I006	I007	/dev/sg3	No
Yes						
enc10/hse0/d1	BootCode	NotRequired	BC04	BC04	/dev/sg3	No
No						
enc10/hse0/d1	Firmware	Updateable	A017	A018	/dev/sg3	No
Yes						
enc10/hse0/d3	ISTR	Updateable	I006	I007	/dev/sg10	No
Yes						
enc10/hse0/d3	BootCode	NotRequired	BC04	BC04	/dev/sg10	No
No						
enc10/hse0/d3	Firmware	Updateable	A017	A018	/dev/sg10	No
Yes						
enc10/hse1/d0	ISTR	Unreachable	I006	I007	NA	No
Yes						
enc10/hse1/d0	BootCode	NotRequired	BC04	BC04	NA	No
No						
enc10/hse1/d0	Firmware	Unreachable	A017	A018	NA	No
Yes						
enc10/hse1/d2	ISTR	Unreachable	I006	I007	NA	No
Yes						
enc10/hse1/d2	BootCode	NotRequired	BC04	BC04	NA	No
No						
enc10/hse1/d2	Firmware	Unreachable	A017	A018	NA	No
Yes						
enc10	FPGA	NotRequired	1.00.023D	1.00.023D	NA	No
No						
enc10/slot36/drive	PCUBootCode	Updateable	6AC0	7EC0	/dev/sdf	Yes
Yes						
enc10/slot36/drive	PCUFirmware	Updateable	6AC0	7EC0	/dev/sdf	Yes
Yes						
enc10/slot36/drive	Firmware	NotRequired	62EL	62EL	/dev/sdf	No
No						

encl0/slot37/drive	PCUBootCode	Updateable	6AC0	7EC0	/dev/sdh	Yes
Yes						
encl0/slot37/drive	PCUFirmware	Updateable	6AC0	7EC0	/dev/sdh	Yes
Yes						
encl0/slot37/drive	Firmware	NotRequired	62EL	62EL	/dev/sdh	No
No						
encl0/slot54/drive	PCUBootCode	Updateable	6AC0	7EC0	/dev/sdg	Yes
Yes						
encl0/slot54/drive	PCUFirmware	Updateable	6AC0	7EC0	/dev/sdg	Yes
Yes						
encl0/slot54/drive	Firmware	NotRequired	62EL	62EL	/dev/sdg	No
No						
encl0/slot58/drive	PCUBootCode	Updateable	6AC0	7EC0	/dev/sde	Yes
Yes						
encl0/slot58/drive	PCUFirmware	Updateable	6AC0	7EC0	/dev/sde	Yes
Yes						
encl0/slot58/drive	Firmware	NotRequired	62EL	62EL	/dev/sde	No
No						
encl0/slot59/drive	PCUBootCode	Updateable	6AC0	7EC0	/dev/sdc	Yes
Yes						
encl0/slot59/drive	PCUFirmware	Updateable	6AC0	7EC0	/dev/sdc	Yes
Yes						
encl0/slot59/drive	Firmware	NotRequired	62EL	62EL	/dev/sdc	No
No						
encl0/slot62/drive	PCUBootCode	Updateable	6AC0	7EC0	/dev/sdb	Yes
Yes						
encl0/slot62/drive	PCUFirmware	Updateable	6AC0	7EC0	/dev/sdb	Yes
Yes						
encl0/slot62/drive	Firmware	NotRequired	62EL	62EL	/dev/sdb	No
No						
encl0/slot63/drive	PCUBootCode	Updateable	6AC0	7EC0	/dev/sdd	Yes
Yes						
encl0/slot63/drive	PCUFirmware	Updateable	6AC0	7EC0	/dev/sdd	Yes
Yes						
encl0/slot63/drive	Firmware	NotRequired	62EL	62EL	/dev/sdd	No
No						

Warning:

One or more elements are not connected to this host
Enclosure may move into reduced functionality mode after update
until those elements are updated through ifcli from remote host

Warning: Unable to access one or more drives because of zoning or drive reservation or
offline/blocked device(s)

CAUTION: After update operation enclosure needs to be power cycled.

Do you want to continue?(Y/N): **y**

Update for encl0

```
encl0 : Update successfully initiated.
encl0 : Update : Drive PCU Boot Code Update started
encl0 : Update : 0% completed
encl0 : Update : Drive PCU Boot Code Update finished
encl0 : Update : Drive PCU F/W Update started
encl0 : Update : 11% completed
encl0 : Update : Drive PCU F/W Update finished
encl0 : Update : 22% completed
encl0 : Update : encl0/hse0:ISTR Updated
encl0 : Update : 33% completed
encl0 : Update : encl0/hse0/d3:ISTR Updated
encl0 : Update : 44% completed
encl0 : Update : encl0/hse0/d1:ISTR Updated
```

```
enc10 : Update : 55% completed
enc10 : Update : enc10/hse0/d3:Firmware Updated
enc10 : Update : 66% completed
enc10 : Update : enc10/hse0/d1:Firmware Updated
enc10 : Update : 77% completed
enc10 : Update : enc10/hse0:Firmware Updated
enc10 : Update : 88% completed
enc10 : Update : Reset done for updated SEB(s)
enc10 : Update : Update completed
enc10 : Update : 100% completed
enc10 : Update completed successfully.
```

Power Cycle for enc10 to complete update.

Command Executed Successfully.

To reboot the IF150, enter the `ifcli enc1 reboot` command. Enter `y` to confirm and initiate the reboot process.

```
C:\DataCore> ifcli enc1 reboot
SanDisk ifcli version 2.2.12
Copyright (C) 2016 SanDisk
08/23/2016 17:47:25

This operation will reboot the enclosure(s). Do you want to continue?(Y/N): y
DeviceName  Status
-----
enc10      Reboot request sent successfully

Command Executed Successfully.
```

InfiniFlash Zone Configuration

This deployment uses a Z2 zoning configuration for the A2 cabling. Use the `ifcli zone` command to set the zoning. Reboot the IF150 after configuring the zone.

```
C:\DataCore> ifcli zone -e enc10 -o update -p InfiniFlashZoneCnf_01.11.zpkg -n Z2
SanDisk ifcli version 2.2.12
Copyright (C) 2016 SanDisk
08/23/2016 17:57:34

Zone configuration updated.
NOTE:Enclosure power cycle is required for the change to take effect.

Command Executed Successfully.
```

After rebooting the IF150, verify the zoning configuration using the `ifcli enc10 show` command.

```
C:\DataCore> ifcli enc10 show
SanDisk ifcli version 2.2.12
Copyright (C) 2016 SanDisk
08/23/2016 18:02:08

DeviceName  State      Identify  Vendor  ProductID  ZoneName
-----
```

```
encl0      OK      OFF      SANDISK  SDIFHS02  Z2
Command Executed Successfully.
```

Create Support Bundle

In order to expedite troubleshooting of any issues that may occur after deployment of the IF150, it is recommended to create a baseline support bundle. For easier reading, the baseline support bundle should be renamed to a user-friendly name. To create a support bundle, enter the following command: `ifcli encl0 createSub`.

```
C:\DataCore> ifcli encl0 createSub -p .
SanDisk ifcli version 2.2.12
Copyright (C) 2016 SanDisk
08/23/2016 18:25:16

Creating support bundle for encl0 (for all accessible SEBs, drives from present host)
-----
encl0 : createSUB started successfully.
encl0 : createSUB : Opening all SES targets
encl0 : createSUB : 16% completed
encl0 : createSUB : 41% completed
encl0 : createSUB : 50% completed
encl0 : createSUB : Completed reading SES Pages, opening drives
encl0 : createSUB : 60% completed
encl0 : createSUB : Collected information from all attached drives
encl0 : createSUB : 80% completed
encl0 : createSUB : Archiving completed
encl0 : createSUB : 100% completed
encl0 : createSUB completed successfully.

Support Archive File Name : .\TME-SJ-S22_5001E82000071540_08232016_182545.zip

Command Executed Successfully
```

DataCore Configuration

Pre-Installation Guidance

DataCore provides an easy-to-use installation wizard for SANsymphony. Prior to running the tool, disable the following Microsoft Windows features. These adversely affect the fundamental storage operations in SANsymphony's software:

- Storage spaces pools with virtual volumes
- iSCSI target volumes

A DataCore recommended best practice is to run the following command on the SANsymphony host systems. This allows faster formatting of large drives and the setting is persistent.

```
fsutil behavior set DisableDeleteNotify 1
```

Installing DataCore SANsymphony

The DataCore Deployment Wizard can be requested for download from the DataCore website at <https://www.datacore.com/products/SANsymphony.aspx>.

For an iSCSI deployment, ensure the Microsoft iSCSI Initiator feature is enabled in the Windows operating system.

The DataCore Deployment Wizard must be run on each host and performs the following actions:

1. Validates the host system meets the prerequisites
 - a. Windows Power Shell version 2.0 or higher
 - b. .NET Framework
 - c. Windows Server version
 - d. Hardware configuration
2. Installation of the SANsymphony software

Figure 17) DataCore SANsymphony Deployment Wizard

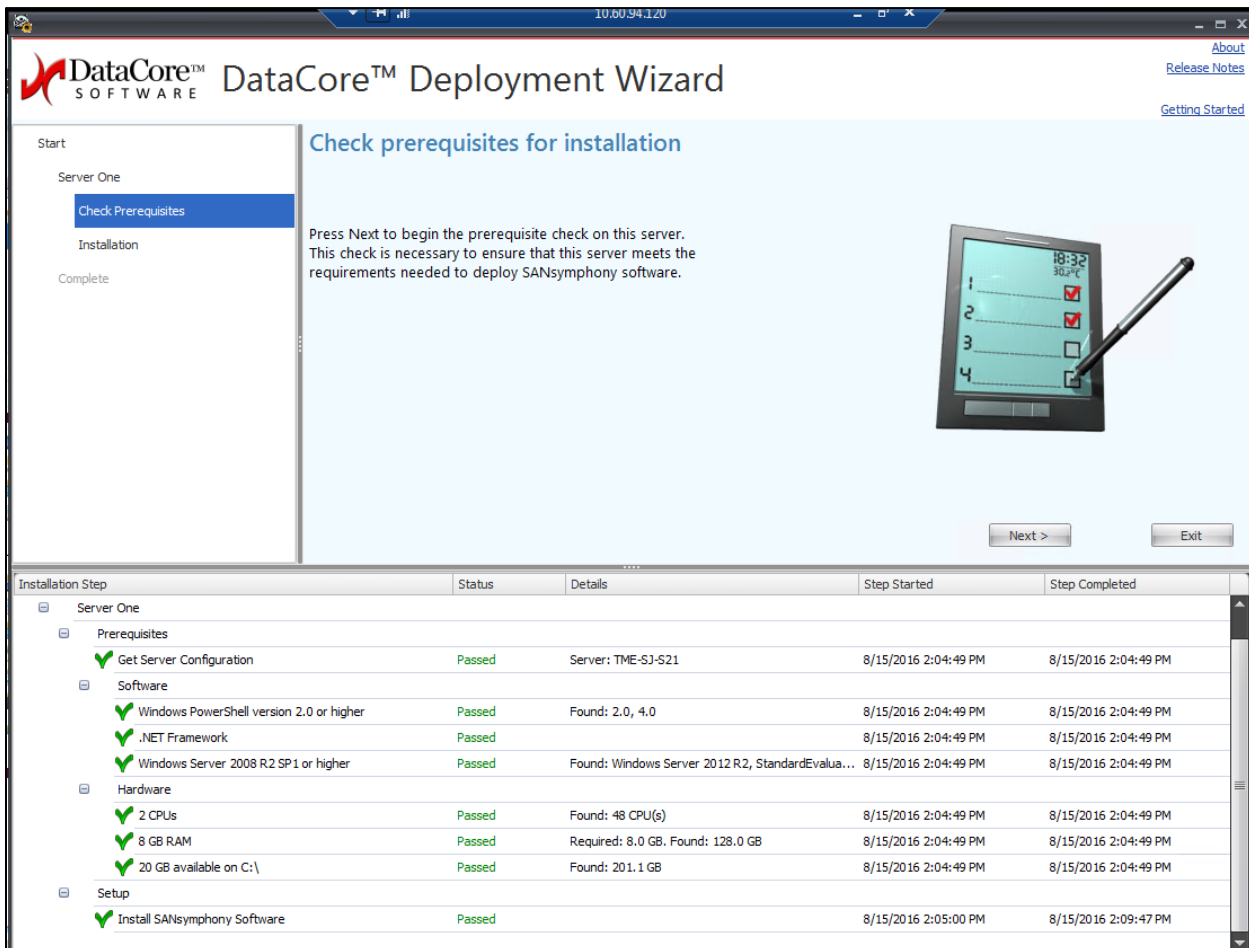

Licensing SANsymphony

Licenses can be added during installation from the deployment wizard, or after installation from the SANsymphony user interface. To add a license, click **Server Group | License | Activate Product Keys**. Enter the license keys and click **Next**.

Figure 18) Activate SANsymphony license keys

The screenshot shows the 'Activate Product Keys' window in the SANsymphony interface. The window title is 'Server Group Server Group'. The 'License' tab is selected, and the 'Activate Product Keys' section is active. The 'Contact Information' section has four input fields: Contact name, Email address, Phone number, and Company name. The 'License Product Keys' section contains a table with four rows, each representing a license key and its activation method. The keys are: 'XXXXX-XXXXX-XXXXX-XXXXX-CQ2ZC', 'XXXXX-XXXXX-XXXXX-XXXXX-W9DNM', 'XXXXX-XXXXX-XXXXX-XXXXX-D00Q8', and 'XXXXX-XXXXX-XXXXX-XXXXX-LJSH0'. The activation methods are: 'TME-SJ-S21', 'TME-SJ-S22', '136 TBs', and '3 TBs'. There are 'Back', 'Next', and 'Cancel' buttons at the bottom right of the window.

License Product Key	Activation Method
XXXXX-XXXXX-XXXXX-XXXXX-CQ2ZC	TME-SJ-S21
XXXXX-XXXXX-XXXXX-XXXXX-W9DNM	TME-SJ-S22
XXXXX-XXXXX-XXXXX-XXXXX-D00Q8	136 TBs
XXXXX-XXXXX-XXXXX-XXXXX-LJSH0	3 TBs

For more detailed installation instructions, see the [Getting Started with SANsymphony](#) support webpage on DataCore Support.

SANsymphony iSCSI Settings

DataCore provides a Windows Power Shell script to assist with tuning SANsymphony and the iSCSI configuration settings. The script performs the following actions:

- Disables scheduled disk defragmentation
- Sets the Windows Power Plan to High Performance
- Creates the iSCSI Net Transport Filter
- Disables the power saving functionality on each NIC
- Disables all protocols other than IPv4 on adaptor(s)
- Disables NAGLE and DELAYED ACK on adaptor(s)
- Disables WINS lookup on adaptor(s)
- Disables DNS Registration on adaptor(s)
- Disables SR-IOV on adaptor(s)
- Sets the following NETSH parameter options

- Enables Receive-Side Scaling State
- Disables Chimney Offload State
- Disables NetDMA State
- Disables Direct Cache Access
- Sets the Receive Window Auto-Tuning Level to NORMAL
- Disables ECN Capability
- Disables RFC 1323 Timestamps
- Sets the Initial RTO to 3000ms
- Enables Receive Segment Coalescing State
- Disables Non-Sack RTT Resiliency
- Sets the Max SYN Retransmissions to 2
- Sets the Custom TCP/IP Template Settings
- Sets the Optimal I/O Cache Queue Parameters

SANsymphony iSCSI Power Shell Script

To execute the iSCSI Settings Helper 1.3 PowerShell script, run the iSCSI-Settings_Helper_v1.3.ps1 script at the Power Shell prompt:

```

PS C:\DataCore\iSCSI-Settings_Helper_v1.3> .\iSCSI-Settings_Helper_v1.3.ps1
>>>>----- SCRIPT START -----<<<<<

Setting Windows Global Settings
    Disabling Scheduled Defrag Task

TaskPath                                TaskName                                State
-----                                -
\Microsoft\Windows\Defrag\              ScheduledDefrag                          Disabled
Setting Windows Power Plan to >High performance<
    success
Creating iSCSI Net Transport Filter

Caption          :
Description      :
ElementName     :
InstanceID      :
CommunicationStatus :
DetailedStatus  :
HealthState     :
InstallDate     :
Name            : Nk~kmoX~o|55@55=<@:55=<@:55:55@??=?554
OperatingStatus :
OperationalStatus :
PrimaryStatus   :
Status          :
StatusDescriptions :
CreationClassName :
IsNegated       :
SystemCreationClassName :
SystemName      :
DestinationPrefix : *
```

```
LocalPortEnd      : 3260
LocalPortStart    : 3260
Protocol          : TCP
RemotePortEnd     : 65535
RemotePortStart   : 0
SettingName       : Datacenter
PSComputerName    :

    success
Disable powersaving functionality on each NIC
    success

Setting individual adapters settings
Disabling protocols other than IPv4 on adapter(s)
Disabling NAGLE and DELAYED ACK on adapter(s)
Disabling WINS lookup on adapter(s)
Disabling DNS Registration on adapter(s)
Disabling SR-IOV on adapter(s)
Setting NETSH Parameters
    Enabling Receive-Side Scaling State: Ok.

    Disabling Chimney Offload State: Ok.

    Disabling NetDMA State: Ok.

    Disabling Direct Cache Access: Ok.

    Setting Receive Window Auto-Tuning Level to NORMAL: Ok.

    Disabling ECN Capability: Ok.

    Disabling RFC 1323 Timestamps: Ok.

    Setting Initial RTO to 3000ms: Ok.

    Enabling Receive Segment Coalescing State: Ok.

    Disabling Non-Sack RTT Resiliency: Ok.

    Setting Max SYN Retransmissions to 2: Ok.

    Setting Custom TCP/IP Template Settings: Ok.

    Setting Optimal IO Cache Queue Parameters: Ok.
Ok.
False
Ok.

NO SCRIPT ERRORS DETECTED

>>>>----- SCRIPT END -----<<<<
Press Enter to Finish:
```

Configuring DataCore SANsymphony

Join the DataCore Servers

After installing and licensing the SANsymphony hosts, the next step is to add the DataCore Servers to the Server Group. Select the Server Group menu item and click **Add DataCore Server**. Enter the IP address of each SANsymphony host and then click **Add** to join the DataCore server.

Configure the iSCSI Port Rules

Each iSCSI connection must be configured as a front-end data connection, a mirror connection, or both. To set the iSCSI port rules, select **iSCSI connection** in the Server Ports menu item, and then click the **Settings** tab.

Figure 19) Configure iSCSI port rules

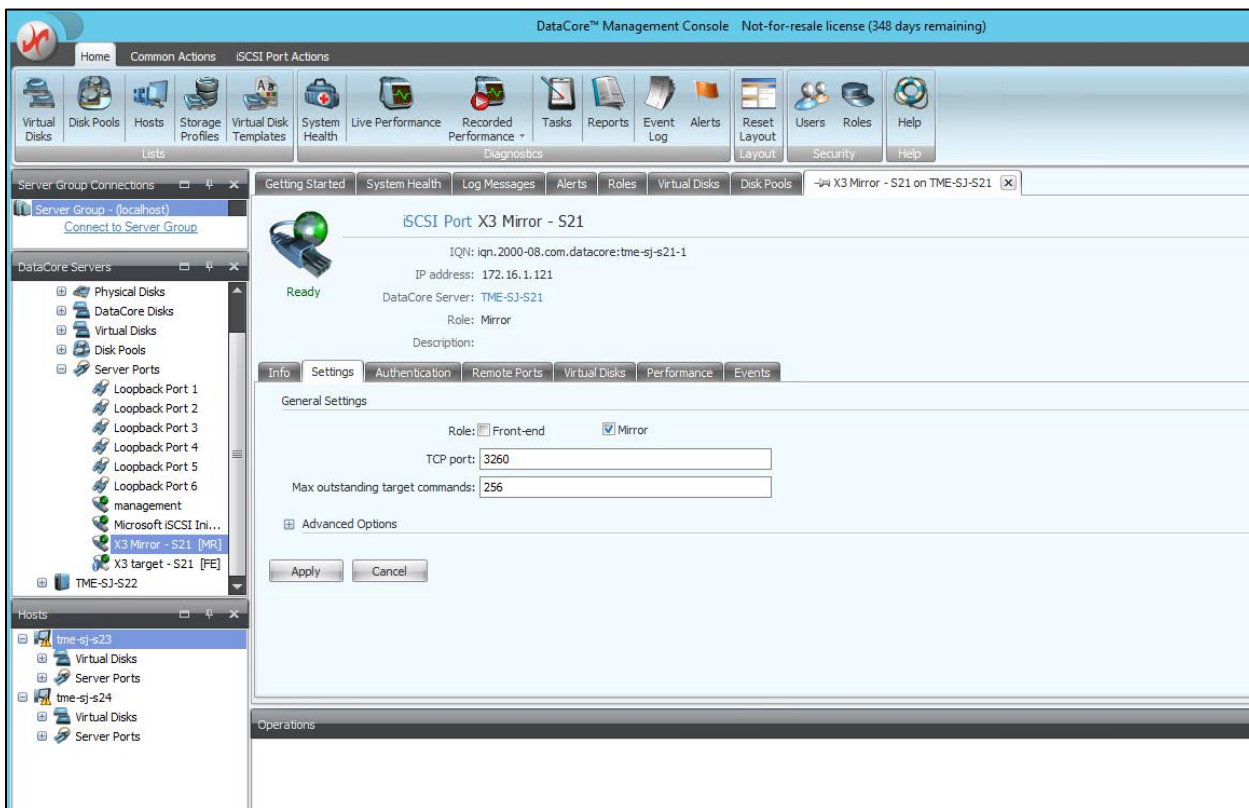

Configuring iSCSI Storage Connection

Create the iSCSI virtual connection between the client hosts and the DataCore SANsymphony hosts. Configuring the iSCSI path is beyond the scope of this document.

For more information, see the [Microsoft iSCSI Initiator Step-by-Step Guide](#) on TechNet.

For more information on the SANsymphony iSCSI Best Practices, visit the DataCore support website at http://datacore.custhelp.com/app/answers/detail/a_id/1626.

Create the iSCSI Mirror Connection

Configure the iSCSI mirror connection between the two DataCore hosts. The mirror connection is a bidirectional path:

- DataCore (1) iSCSI initiator to DataCore (2) iSCSI target
- DataCore (2) iSCSI initiator to DataCore (1) iSCSI target

For more information, see the [Microsoft iSCSI Initiator Step-by-Step Guide](#) on TechNet.

For more information on the SANsymphony iSCSI Best Practices, visit the DataCore support website at http://datacore.custhelp.com/app/answers/detail/a_id/1626.

Create Disk Pools

Each SANsymphony host must have a disk pool which contains the disks to mirror with the HA partner.

The disk pools in this example are configured as follows:

- Disk Pool 1
 - 32 x 8TB flash drives
 - 4,096B block size
- Disk Pool 2
 - 32 x 8TB flash drives
 - 4,096B block size

To create a disk pool, select **Disk Pool** and click the **Create Disk Pool** tab. Enter the name of the Disk Pool, the SANsymphony server, allocation size, and the sector size (4 KB), and then click **Create**.

A DataCore recommended best practice is to set the allocation size to 128MB. The only exception is when using snapshots; in this case, DataCore recommends setting the allocation size to 4MB.

Figure 20) Create a disk pool

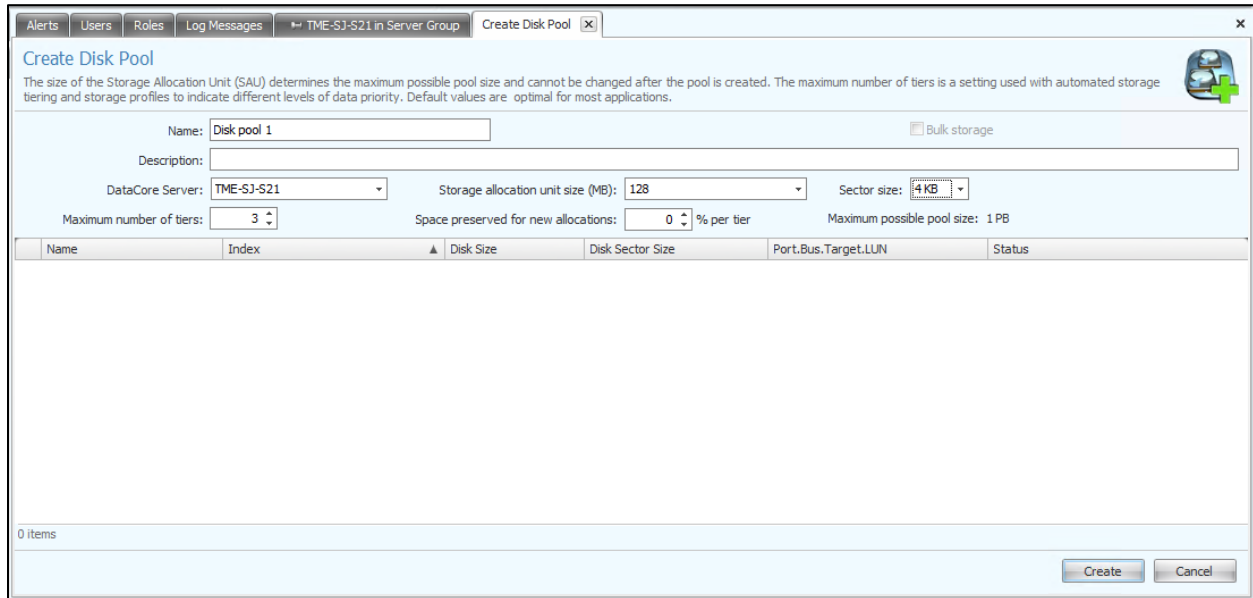

Once the disk pool is created, add the physical disks to the disk pool. Select the disk pool name and click the **Physical Disk** tab. Then click the **Add Physical Disks** link. Select the physical disk to be added to the pool and click **Add**.

Figure 21) Add physical disks to the disk pool

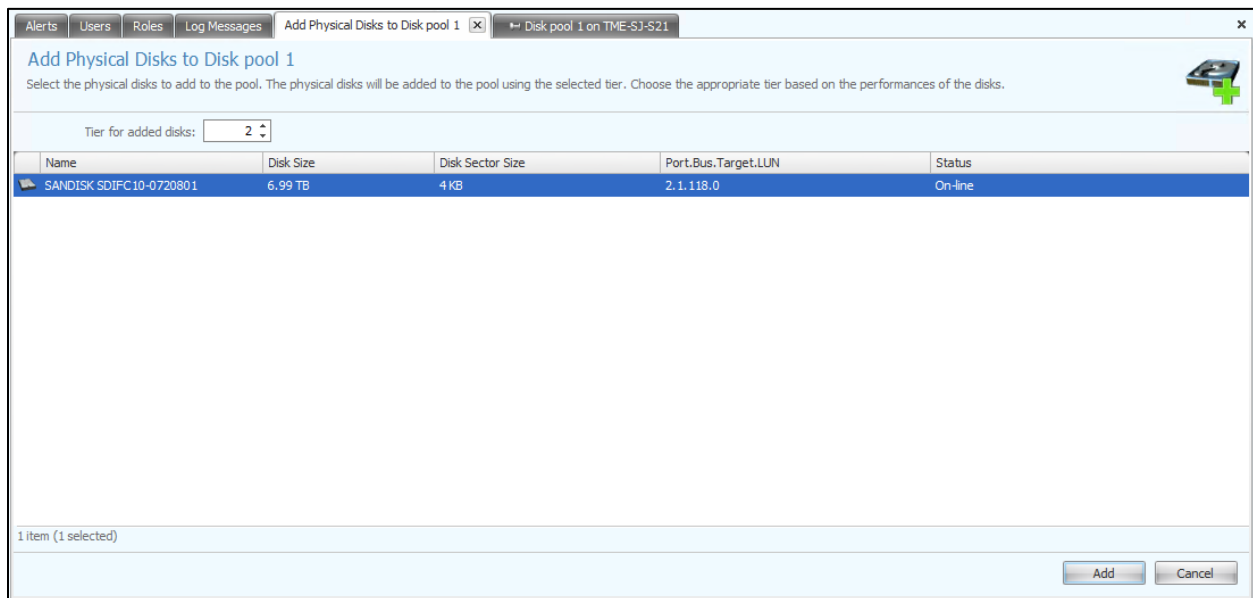

Once a disk is added to the disk pool, SANsymphony begins a reclamation process to prepare the disks. Full reclamation may take longer than eight hours for a fully populated InfiniFlash IF150 with 64 x 8TB SSDs. Fortunately, the disks are available during reclamation.

Note: Performance testing should not be initiated until reclamation has completed.

Note: Some disks may require running the Windows disk partitioning utility (`diskpart.exe`) to clean the drive prior to adding it to the SANsymphony disk pool. If necessary, each storage disk must be cleaned individually. Be careful not to clean your boot drive or local devices.

```
C:\DataCore> diskpart

Microsoft DiskPart version 6.3.9600

Copyright (C) 1999-2013 Microsoft Corporation.
On computer: TME-SJ-S21

DISKPART> list disk

   Disk ###  Status              Size               Free                Dyn  Gpt
   -----  -
   Disk 0    Online              7153 GB            7153 GB
   Disk 1    Online              7153 GB            7153 GB
   Disk 2    Online              7153 GB            7153 GB
   Disk 3    Online              7153 GB            7153 GB
   Disk 4    Online              7153 GB            7153 GB
   Disk 5    Online              7153 GB            7153 GB
   Disk 6    Online              7153 GB            7153 GB
   Disk 7    Online              7153 GB            7153 GB
   Disk 8    Online              7153 GB            7153 GB
   Disk 9    Online              7153 GB            7153 GB
   Disk 10   Online              7153 GB            7153 GB
   Disk 11   Online              7153 GB            7153 GB
   Disk 12   Online              7153 GB            7153 GB
   Disk 13   Online              7153 GB            7153 GB
   Disk 14   Online              7153 GB            7153 GB
   Disk 15   Online              7153 GB            7153 GB
   Disk 16   Online              7153 GB            7153 GB
   Disk 17   Online              7153 GB            7153 GB
   Disk 18   Online              7153 GB            7153 GB
   Disk 19   Online              7153 GB            7153 GB
   Disk 20   Online              7153 GB            7153 GB
   Disk 21   Online              7153 GB            7153 GB
   Disk 22   Online              7153 GB            7153 GB
   Disk 23   Online              7153 GB            7153 GB
   Disk 24   Online              7153 GB            7153 GB
   Disk 25   Online              7153 GB            7153 GB
   Disk 26   Online              7153 GB            7153 GB
   Disk 27   Online              7153 GB            7153 GB
   Disk 28   Online              7153 GB            7153 GB
   Disk 29   Online              7153 GB            7153 GB
   Disk 30   Online              7153 GB            7153 GB
   Disk 31   Online              7153 GB            7153 GB

DISKPART> select disk 0

Disk 0 is now the selected disk.

DISKPART> clean
```

Note: Once a disk is added to the SANsymphony Disk Pool it cannot be managed by the Windows Disk Management interface. Actions to the disk can only be completed from SANsymphony. A disk can be removed from the disk pool, and then released back to the Windows operating system.

Auto-Tiering

Auto-tiering is a feature of DataCore that allows different workloads to utilize different storage types. For high-demand workloads, the InfiniFlash IF150 functions as the Tier-1 storage device. Existing DataCore customers can add the IF150 storage platform for Tier-1 and keep their existing Tier-2 or Tier-3 storage, all under the control of SANsymphony.

- Tier 1: Highest performance-class disk device (i.e. Flash, SSD)
- Tier 2: High performance-class disk device (i.e. 15k SAS)
- Tier 3: Moderate performance-class disk device (i.e. NL-SAS)
- Tier 4: Slow performance-class disk device (i.e. Internal or external SATA)

For more information, see the [Automated Storage Tiering – How it Works FAQ](#) on the DataCore Support website.

Create a Virtual Disk

A DataCore virtual disk is created by selecting **Virtual Disk** from the menu, selecting the Virtual Disk tab, and then clicking **Create Virtual Disk**. Enter the name, virtual disk size, reserved space, and sector (block) size. Click the **Next** button to move to the next step.

Note: By default, all virtual disks are thin provisioned. Virtual disks can be thick provisioned, up to the size of the virtual disk, with the Reserved Space parameter.

Figure 22) Create a virtual disk

The screenshot shows the 'Create Virtual Disk' wizard in SANsymphony. The window title is 'Create Virtual Disk' and the current step is 'Step 1 of 3: Set Virtual Disk Properties'. The interface includes the following fields and options:

- Name:** Virtual disk 1
- Description:** (empty)
- Type:**
 - Single: One DataCore Server with a single storage source.
 - Dual: Two DataCore Servers with a shared storage source. Provides fault tolerance at the server level.
 - Mirrored: Two DataCore Servers with two mirrored storage sources. Provides fault tolerance at the server and storage level.
- Size:** 32 TB
- Reserved space:** 0 GB
- Assign ownership to me
- Quantity:** 1
- Sector size:** 4 KB

Navigation buttons at the bottom include '< Back', 'Next >', and 'Cancel'.

This deployment uses a RAID 1 configuration with a mirrored data pool on each HA host. Select **Disk Pool 1** and **Disk Pool 2** on the SANsymphony hosts and then click **Next**.

Figure 23) Select storage source

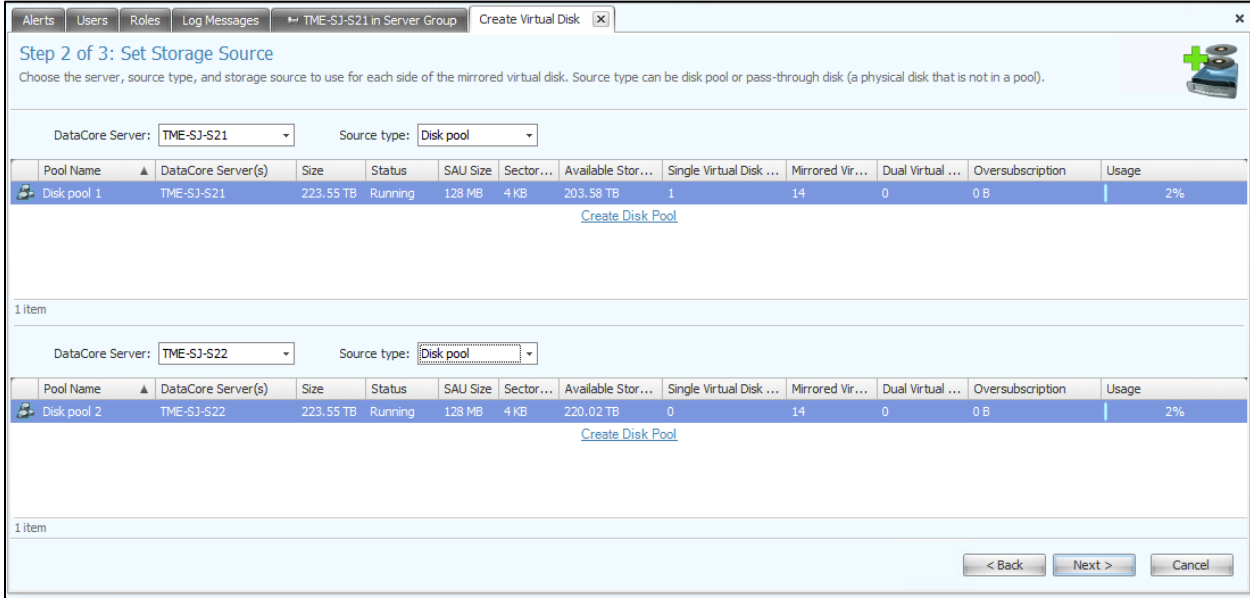

The final step to create virtual disks is to review the Storage Profile and Mirror Paths, then click **Finish**.

Figure 24) Setting virtual disk advanced options

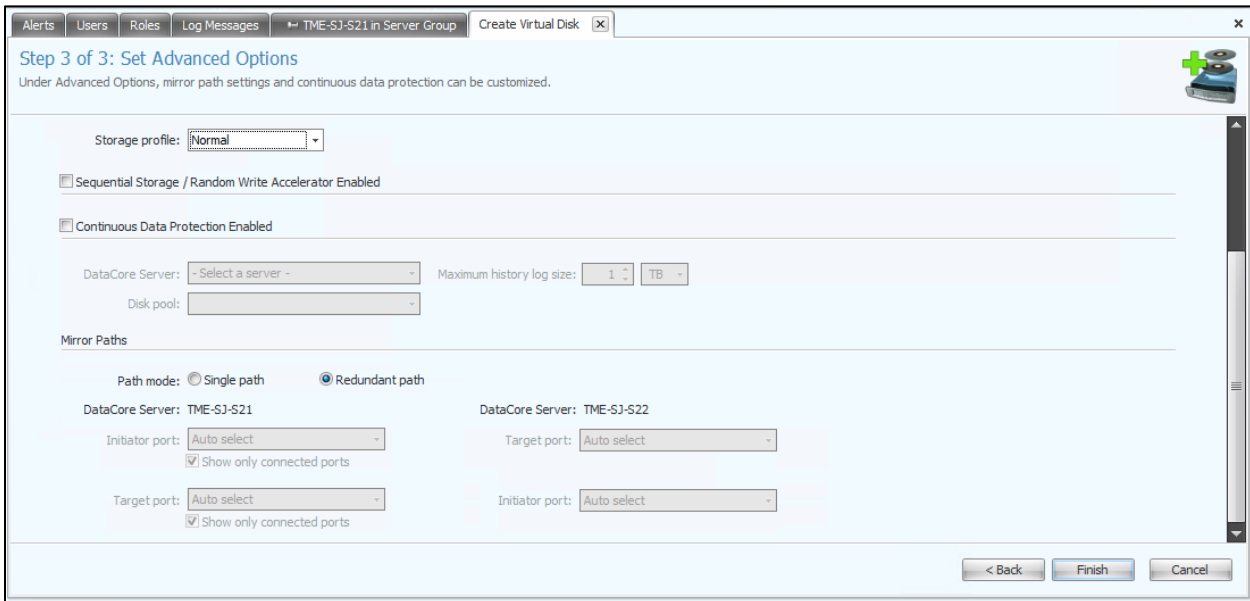

After creating the virtual disk, verify the virtual disk is available by selecting **Virtual Disks** in the menu.

Figure 25) Displaying the virtual disks

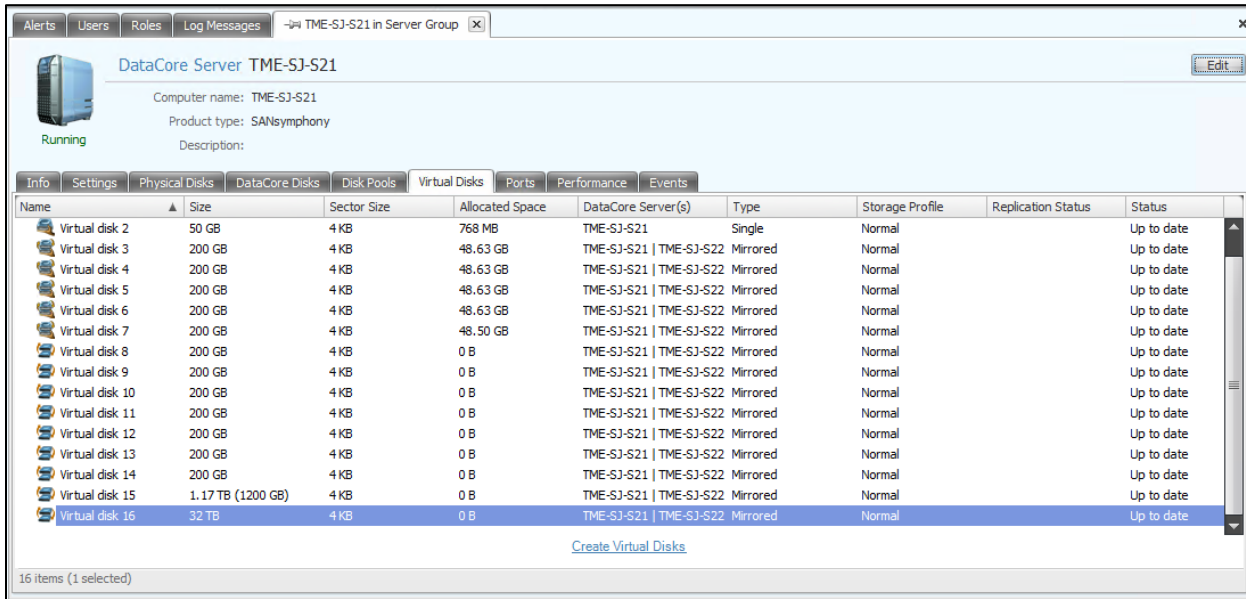

The new virtual disk must be served to the SANsymphony hosts so they can be used by an application. To serve the virtual disk to the hosts, select the virtual disk from the Virtual Disk menu and select the **Serve Virtual** Disk to Hosts tab. Select the hosts to serve the virtual disks to. Click **Next** to go to the next step.

Figure 26) Serve virtual disks to hosts

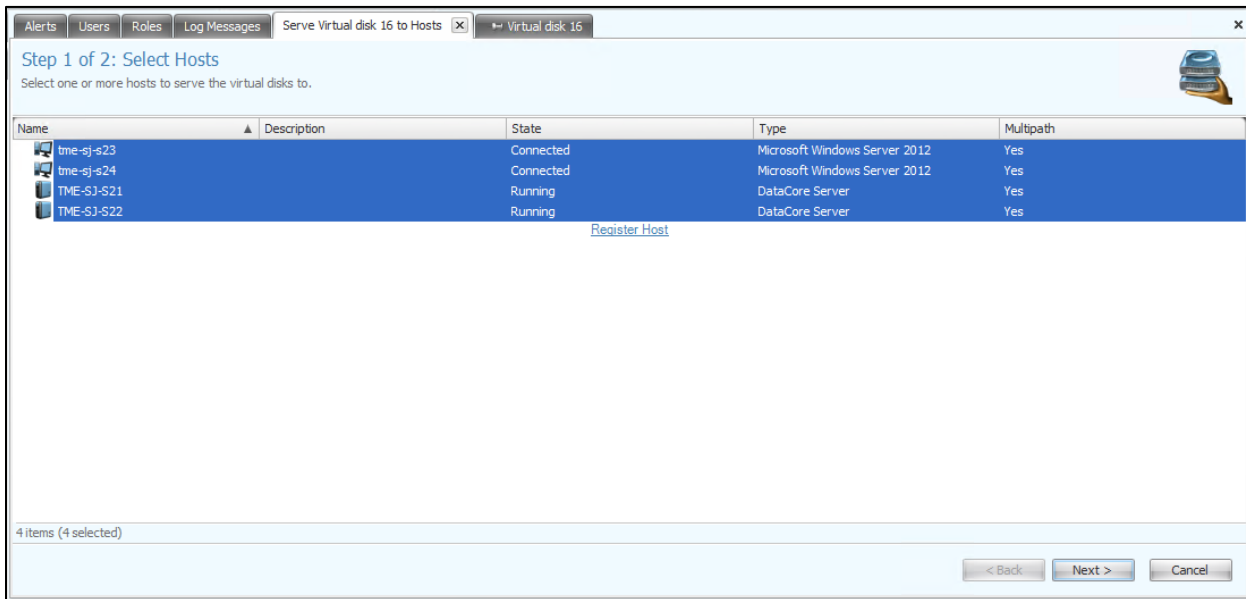

The final step is to select the paths for the hosts. Use the Initiator and Target Port dropdown menus to choose the paths. For this deployment, Auto select automatically chose the iSCSI path. Click Finish to complete serving the virtual disk to the hosts.

Figure 27) Select paths

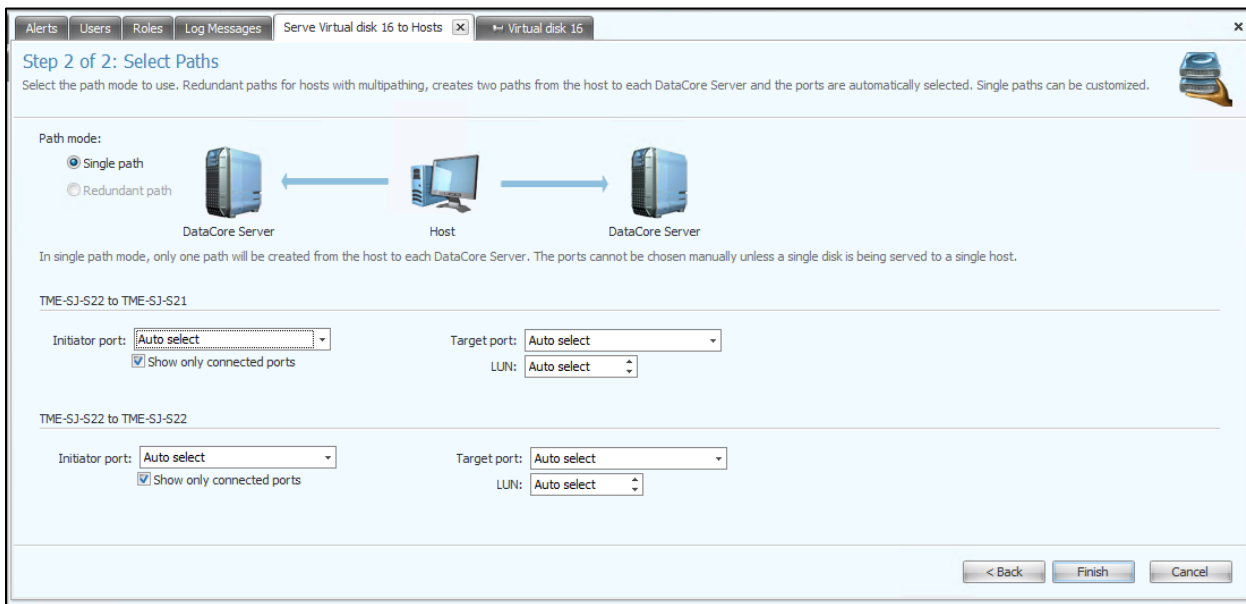

After serving the virtual disks and adding the iSCSI path details, the iSCSI paths are displayed in SANsymphony.

Figure 28) Verify the virtual disk paths

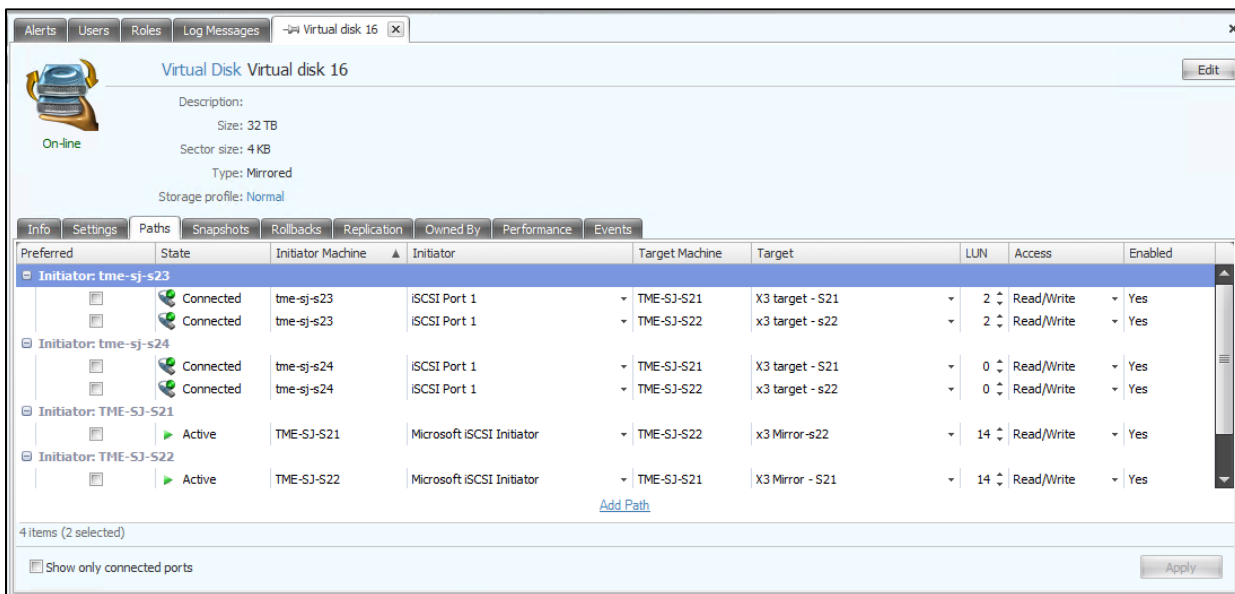

The virtual disk is now available on the host initiator system.

Logging and Monitoring

SANsymphony has several methods for observing the status and events of the DataCore system.

Live Performance Monitoring

DataCore’s Live Performance monitoring utility provides a configurable interface to choose and graph live performance.

Figure 29) Monitoring live performance

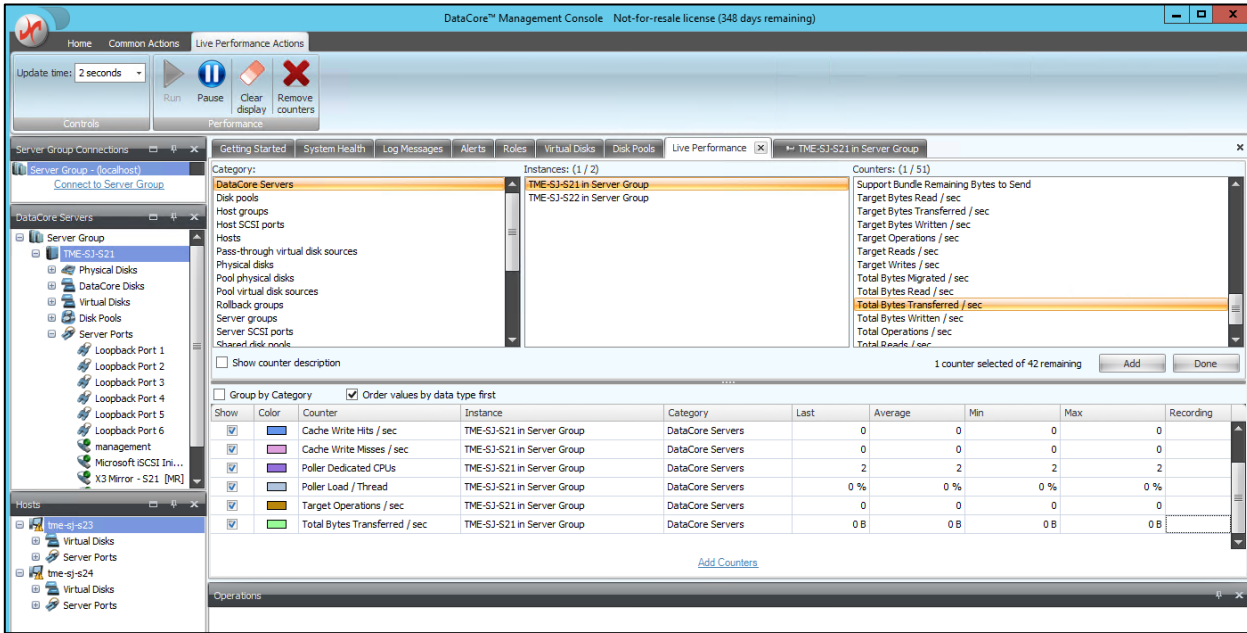

Server Group Alerts

Figure 30) Server group alerts

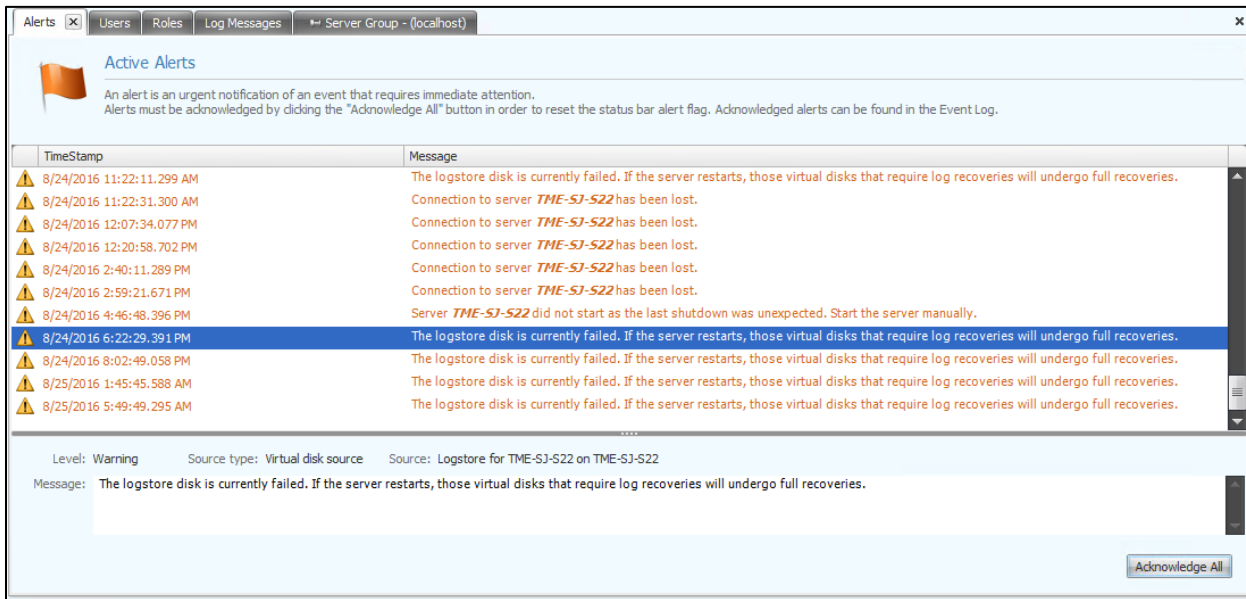

Operations Event Log

Figure 31) Operations event log

Operations			
✓	8/25/2016 1:07:42.831 PM	Add physical disk(s) to pool	Done
✓	8/25/2016 1:07:43.550 PM	Add physical disk 'SANDISK SDIFC10-0720801' to pool 'Disk pool 1'	Done
✓	8/25/2016 1:08:01.347 PM	Add physical disk(s) to pool	Done
✓	8/25/2016 1:08:01.628 PM	Add physical disk 'SANDISK SDIFC10-0720801' to pool 'Disk pool 1'	Done
✓	8/25/2016 1:57:12.594 PM	Add physical disk(s) to pool	Done
✓	8/25/2016 1:57:12.782 PM	Add physical disk 'SANDISK SDIFC10-0720801' to pool 'Disk pool 1'	Done
✓	8/25/2016 2:23:28.078 PM	Create virtual disk - Virtual disk 16	Done
✓	8/25/2016 2:23:28.812 PM	Rescanning port Microsoft iSCSI Initiator on TME-SJ-S21.	Done
✓	8/25/2016 2:23:29.281 PM	Rescanning port Microsoft iSCSI Initiator on TME-SJ-S21.	Done
✓	8/25/2016 2:23:33.781 PM	Rescanning port Microsoft iSCSI Initiator on TME-SJ-S22.	Done
✓	8/25/2016 2:23:58.781 PM	Rescanning port Microsoft iSCSI Initiator on TME-SJ-S21.	Done
✓	8/25/2016 2:24:08.781 PM	Rescanning port Microsoft iSCSI Initiator on TME-SJ-S22.	Done
✓	8/25/2016 3:10:10.935 PM	Serve virtual disk	Done
✓	8/25/2016 3:10:11.325 PM	Rescanning port Loopback Port 1 on TME-SJ-S22.	Done
✓	8/25/2016 3:12:15.700 PM	Remove path - Loopback Port 1 on TME-SJ-S22 Loopback Port 1 on TME-SJ-S22 LUN 0	Done
✓	8/25/2016 3:12:16.550 PM	Rescanning port Loopback Port 1 on TME-SJ-S22.	Done

Host Log Messages

Figure 32) Host log messages

Alerts		Users		Roles		Log Messages		Create Disk Pool		TME-SJ-S21 in Server Group	
Search:											
TimeStamp	Message										
8/24/2016 4:50:31.802 PM	Virtual disk Virtual disk 15 is up-to-date.										
8/24/2016 4:50:31.802 PM	Virtual disk Virtual disk 15 is currently Redundancy failed .										
8/24/2016 4:50:32.099 PM	Client access to Virtual disk 9 on TME-SJ-S22 changed to ReadWrite .										
8/24/2016 4:50:32.099 PM	Virtual disk Virtual disk 9 is currently On-line .										
8/24/2016 4:50:32.099 PM	Client access to Virtual disk 10 on TME-SJ-S22 changed to ReadWrite .										
8/24/2016 4:50:32.099 PM	Virtual disk Virtual disk 10 is currently On-line .										
8/24/2016 4:50:32.099 PM	Client access to Virtual disk 11 on TME-SJ-S22 changed to ReadWrite .										
8/24/2016 4:50:32.099 PM	Virtual disk Virtual disk 11 is currently On-line .										
8/24/2016 4:50:32.099 PM	Client access to Virtual disk 12 on TME-SJ-S22 changed to ReadWrite .										
8/24/2016 4:50:32.099 PM	Virtual disk Virtual disk 12 is currently On-line .										
8/24/2016 4:50:32.099 PM	Client access to Virtual disk 13 on TME-SJ-S22 changed to ReadWrite .										
8/24/2016 4:50:32.099 PM	Virtual disk Virtual disk 13 is currently On-line .										
8/24/2016 4:50:32.099 PM	Client access to Virtual disk 14 on TME-SJ-S22 changed to ReadWrite .										
8/24/2016 4:50:32.099 PM	Virtual disk Virtual disk 14 is currently On-line .										
8/24/2016 4:50:32.099 PM	Client access to Virtual disk 15 on TME-SJ-S22 changed to ReadWrite .										

Task Manager

The Windows Task Manager also provides monitoring of the CPU, memory, processes, and network traffic.

Figure 33) Task manager

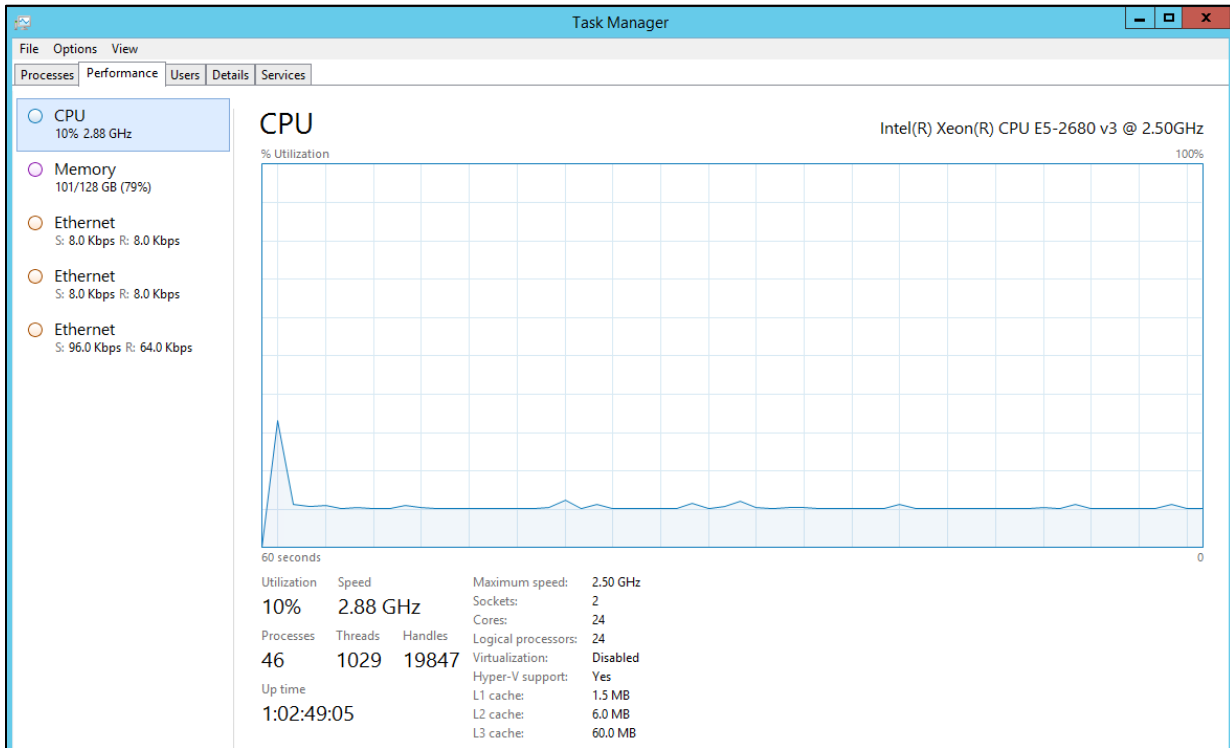

References

- DataCore Support website
<https://datacore.custhelp.com/app/home>
- Getting Started with SANsymphony
https://www.datacore.com/SSV-Webhelp/getting_started_with_SANsymphony.htm
- SANsymphony iSCSI Best Practices
http://datacore.custhelp.com/app/answers/detail/a_id/1626
- DataCore Parallel Server SPC-1 Benchmark Report
<http://link.sandisk.com>
- InfiniFlash IF150 Best Practices Guide
<http://link.sandisk.com>
- InfiniFlash IF150 Software Installation Guide
<http://link.sandisk.com>
- InfiniFlash IF150 Troubleshooting Guide
<http://link.sandisk.com>
- Avago Support website
<http://www.avagotech.com/support>
- Microsoft TechNet iSCSI Initiator Step-by-Step Guide
[https://technet.microsoft.com/en-us/library/ee338476\(v=ws.10\).aspx](https://technet.microsoft.com/en-us/library/ee338476(v=ws.10).aspx)
- DataCore – The Host Server – Qualified Software Components
<http://datacore.custhelp.com/ci/fattach/get/287852/1463581756/redirect/1/filename/Qualified%20Software%20Components.pdf>
- DataCore – Known Issues – Third Party Hardware and Software
<http://datacore.custhelp.com/ci/fattach/get/289847/1465466407/redirect/1/filename/Third%20Party%20Known%20Issues.pdf>

Product specifications provided are sample specifications and do not constitute a warranty. Actual specifications for unique part numbers may vary. Please visit the Support section of our website, <http://kb.sandisk.com/>, for additional information on product specifications. Photographs may show design models.

©2016 Western Digital Corporation or its affiliates. All rights reserved. SanDisk and the SanDisk logo are trademarks of Western Digital Corporation or its affiliates, registered in the U.S. and other countries. InfiniFlash is a trademark of Western Digital Corporation or its affiliates. Other brand names mentioned herein are for identification purposes only and may be the trademark(s) of their respective holder(s). 5121EN 20160908 Rev. 1.

Western Digital Technologies, Inc. is the seller of record and licensee in the Americas of SanDisk® products.